

CONDOR

Automatic Key Cutting Machine
XC-MINI PLUS II

User Manual

V1.0

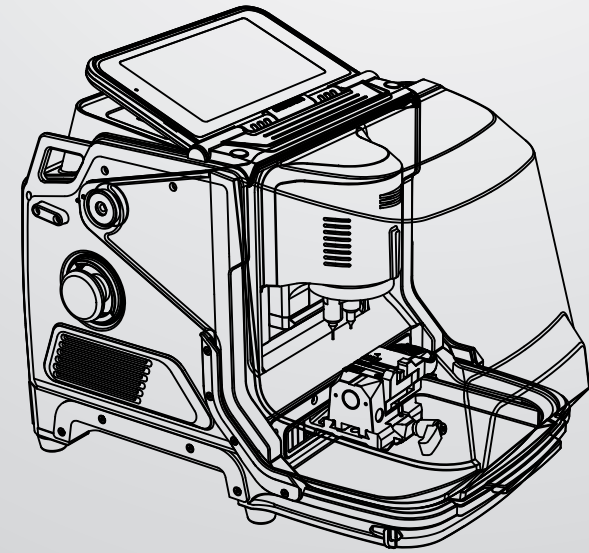



XC-MINI PLUS II
Automatic Key Cutting Machine

TABLE OF CONTENTS

1	Safety precautions and warnings	02
2	General information	
2.1	Machine description	03
2.2	Machine feature	03
3	Product packaging checklist	04
4	Overview	
4.1	Structure diagram	06
4.2	Specification	07
5	Installation instruction	
5.1	Cutter installation	08
5.2	Cutter uninstallation	09
5.3	Clamp installation	10
5.4	Pictures of clamps	11
5.5	Clamp M5 instruction	12
6	Instructions for use the machine	
6.1	Activate the machine	13
6.2	Online upgrade	17
6.3	Instructions for use the machine	18
6.4	Car key/Motorcycle key learning	20
6.5	Car key/Motorcycle key cutting	29
6.6	All key lost	36
6.7	Find Bitting	39
6.8	Household	42
6.9	Key blank engraving	45
6.10	Manual cutting	47
6.11	Customize key data	48
7	Maintenance	54
8	After-sale description	54

1. Safety precautions and warnings

To avoid injuries to operators and damages to the machine, please read this product user manual carefully before you start, and follow the safety notes shown below:

- Always use the machine under safe environment.
- Wear protective goggles that are in line with ANSI standard.
- Put down the protective shield when the machine is working.
- Do not have clothes, hair, hands and other tools close to the machine when it is working.
- DO not leave the machine unattended when it is working.
- Do not use a damaged or loose socket.
- Unplug the machine when it is not in use for a long time.
- Do not put the machine in a place that is damp, greasy and dusty.
- Do not put things like tool or containers on the machine.
- Put the machine on a flat and firm surface .
- Keep the machine dry and clean.
- Unplug the machine under unusual circumstance.

2. General information

2.1 Machine description

Dear customers, thank you for choosing XC-MINI PLUS II automatic key cutting machine. The CONDOR XC- MINI PLUS II automatic key cutting machine is a carefully built for locksmiths around the world. It is small in size, light in weight, and convenient to carry. It can quickly and accurately copy and process all kinds of automobile and household mechanical keys.

To avoid injuries and financial loss, please carefully read this manual through before you start to operate the machine. And we kindly remind you to keep this manual properly for future reference.

2.2 Machine feature









CONDOR XC-MINI PLUS II is a new generation of portable key CNC processing machine, the product has the following characteristics:

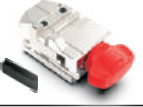
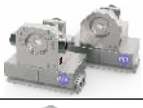





- Built-in database
- Support APP Control
- Intelligent operating system, equipped with eight-core CPU
- Smart LED indicator
- Angle adjustable LCD touch screen
- Support WiFi and Bluetooth
- Support multiple languages^①
- Support engraving function
- All-aluminum body structure
- High precision ball screw
- High rigidity cross rail
- Cutter and probe work in parallel
- Support Multiple Clamps
- Support vehicle/motorcycle/residential(Sided/Track/Tibbe/Dimple) Key^②

① Only for the global version

② Part of special keys are required to use optional clamp

3. Product packaging checklist

	Name	Sample picture	Quantity	Description
	Machine		1	Key cutting machine
Support clamp type	Clamp M5 and link stopper		1	Cutting clamp
	Clamp M3		1	FO21/SX9key clamp
	Clamp M1 (Optional)		1	Cutting clamp
	Clamp M2 (Optional)		1	Cutting clamp
	Clamp M4 (Optional)		1	Household key clamp
	Support accessories	2.5mm cutter		1
1.5mm cutter			1	Cutting tool (Ø1.5xØ6x40L)
Probe			2	Probing tool (Ø1.0xØ6x40L)
2mm+4mm hexagon bar wrench			1	Changing probes and cutters, keys fixation

	Brush		1	Cleaning tool
Support power cord	1.5m Power cord of China standard		1	connect to power
	1.5m Power cord of UK standard(Optional)		1	connect to power
	1.5m Power cord of US standard(Optional)		1	connect to power
	1.5m Power cord of EU standard(Optional)		1	connect to power
	Product quality certificate		1	Factory inspection report and packing list
	User manual		1	Machine assembly/adjustment /operation instruction

Notes:

- Replace cutters regularly to ensure cutting efficiency.

4. Overview

4.1 Structure diagram



4.2 Specification

Input Voltage	90-264V AC/ 24V DC
Input Frequency	47~63Hz
Consume	200W
Display	1280×720
Spindle Speeds	10000rpm
Communication interface	Dual Frequency WiFi & Bluetooth
Working Temperature	0~50°C
Working Humidity	10~90%
Packing Dimensions	515×480×380 mm
Machine Dimensions	250×413×300 mm
Net Weight	19.5Kg
Gross Weight	24Kg

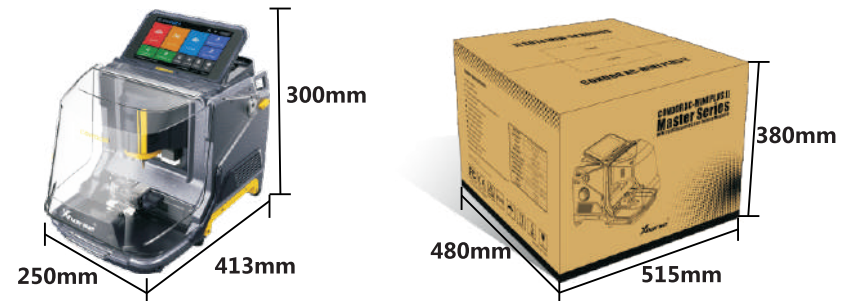

5. Installation instruction

5.1 Cutter installation

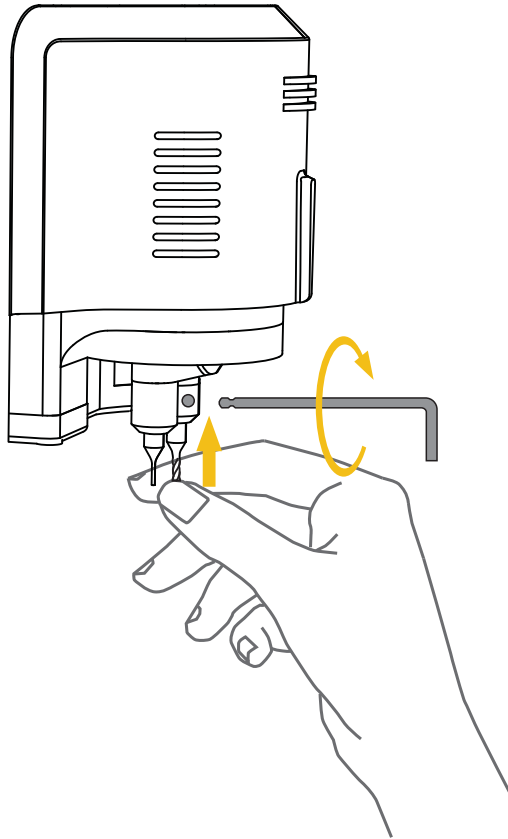

Installation steps:

- 1) Put the cutter into the mounting hole and make sure the cutter goes to the limit of top.
- 2) Use the cutter tightening wrench to clockwise fix the cutter.

5.2 Cutter uninstallation

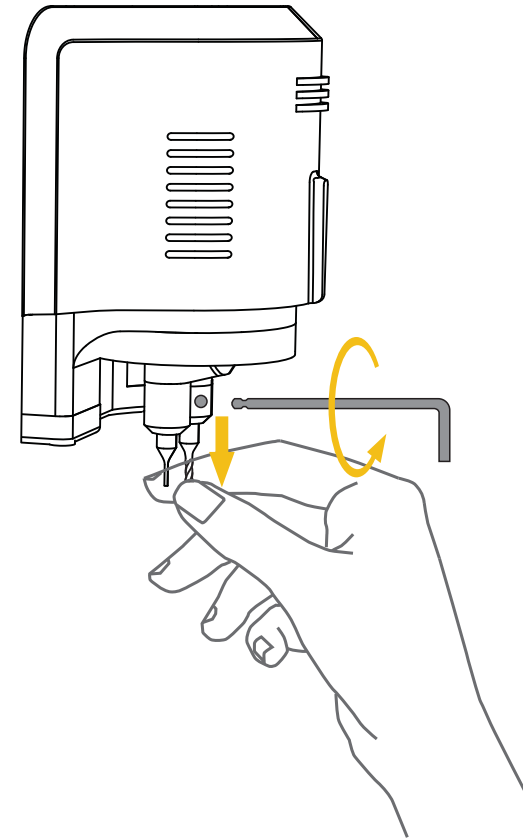

Uninstallation steps:

- 1) Counter-clockwise unscrew the cutter manually.
- 2) Take the cutter off when it is loose.

5.3 Clamp installation

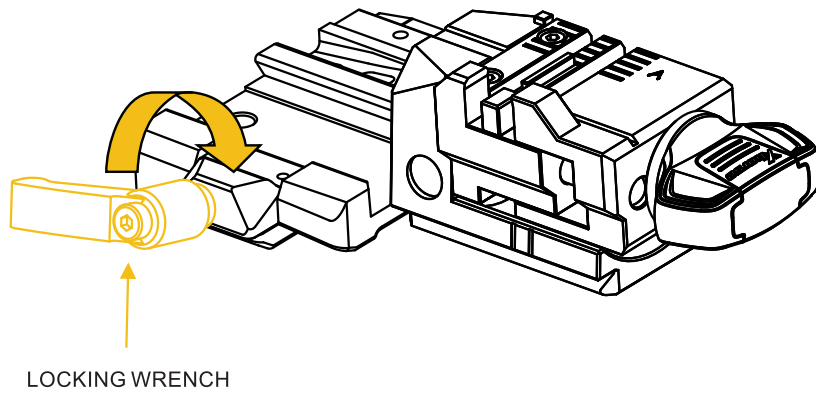

Installation steps:

- 1) Loosening the clamp tightening wrench by turning it counter-clockwise to the left.
- 2) Select the correct clamp and slide in the clamp to the clamp holder and push it to the limit of left.
- 3) After the clamp is put in the clamp platform, turn the clamp tightening wrench clockwise for fix it.

5.4 Pictures of clamps

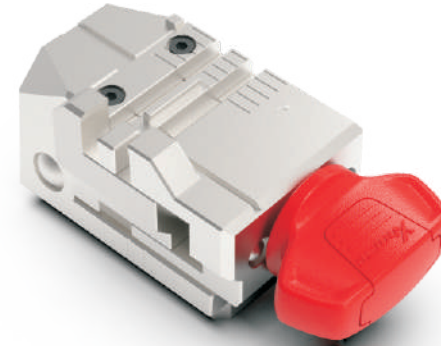

Clamp M5

Supporting type (as picture below)



Standard single/double sided key

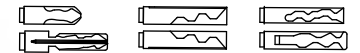

4 Track external 2 Track external 4 Track internal

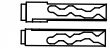

Channel track



Clamp M3

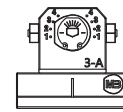

Support type (FO21 example)



FO21

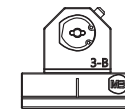

Support type (SX9 example)



SX9



Clamp M4

Supporting type (as picture below)

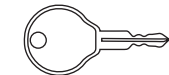

5.5 Clamp M5 instruction

The device adopts M5 clamp with two sides of A and B. Users can turn the clamp surface to cut according to cutting needs, it's no need to repeated install and uninstall to replace different clamps. Here are the method of using the M5 clamp.

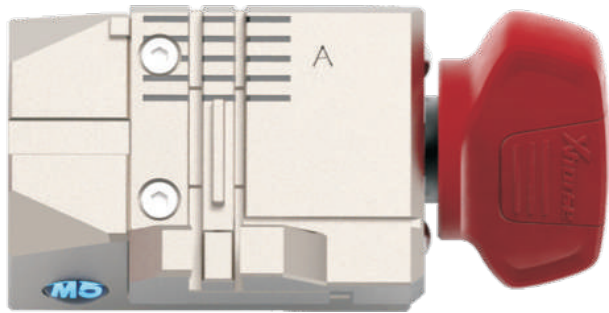

- 1) Loosen the "key lock knob" counterclockwise to make the right slider of the clamp to the right limit.

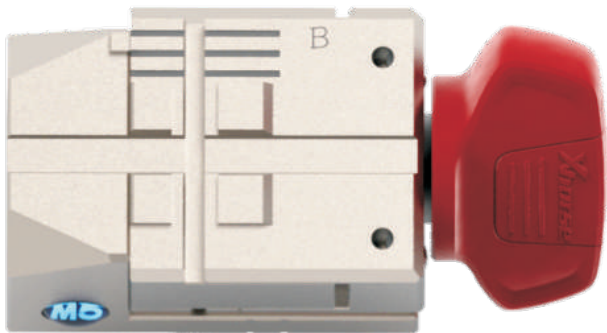

- 2) Turn the movable module clockwise, and turn the clamp from side A to side B. Tighten the "key lock knob" clockwise to lock the clamp.

6. Operation instructions

6.1 Activate the machine

- 1) Select the machine language.

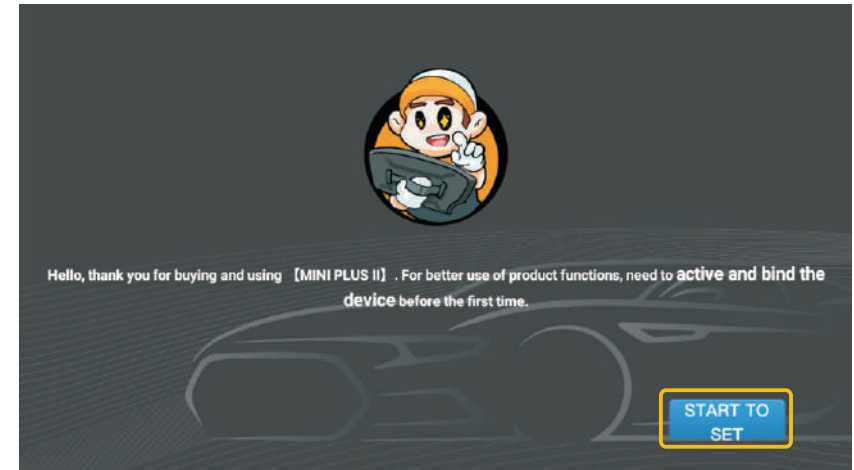

- 2) After the machine is connected to the power cord, turn it on, enter the main interface, and click the "START TO SET" button.

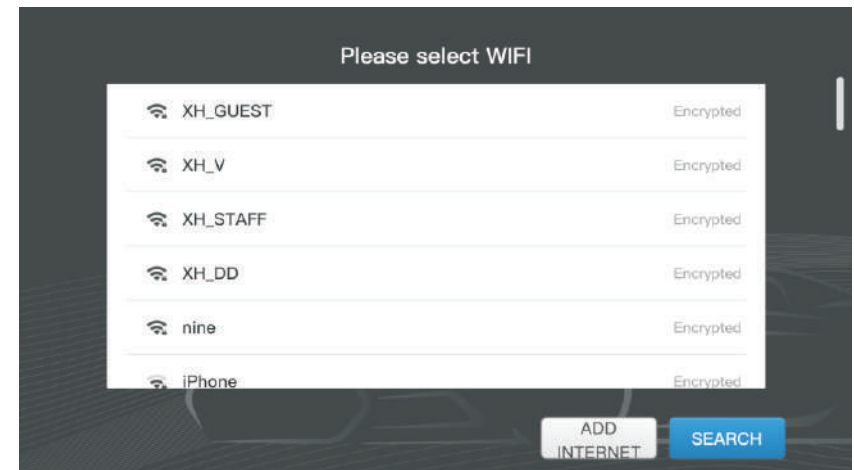

- 3) Click to select a WiFi network.

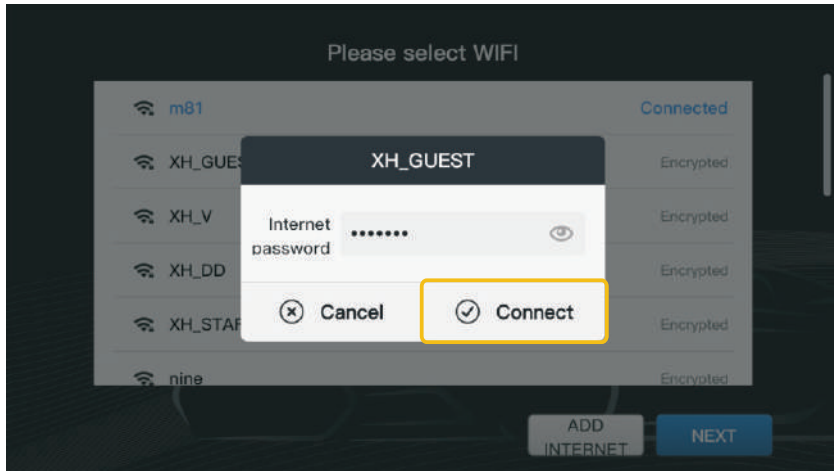

4) After entering the password, click the "Connect" button, and click "NEXT" below after success. (Login the XHORSE account)

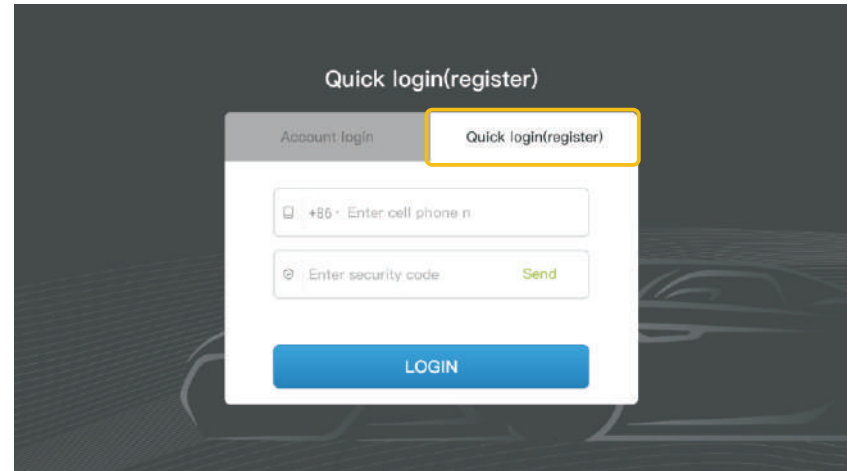
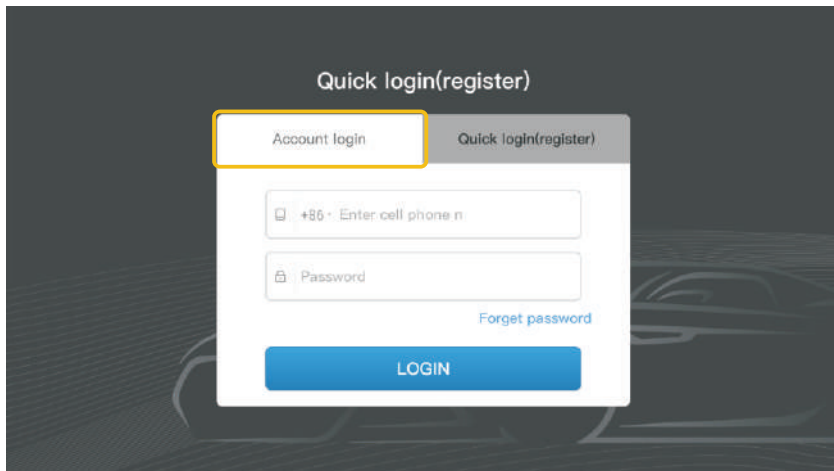

5) Users can choose account login or quick login (new users need to choose quick login and register).

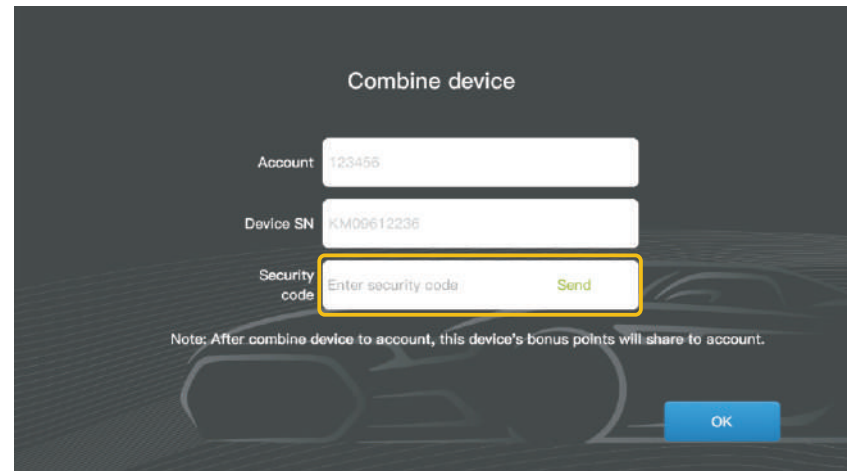

6) After logging in successfully, click "Send" to bind the device.

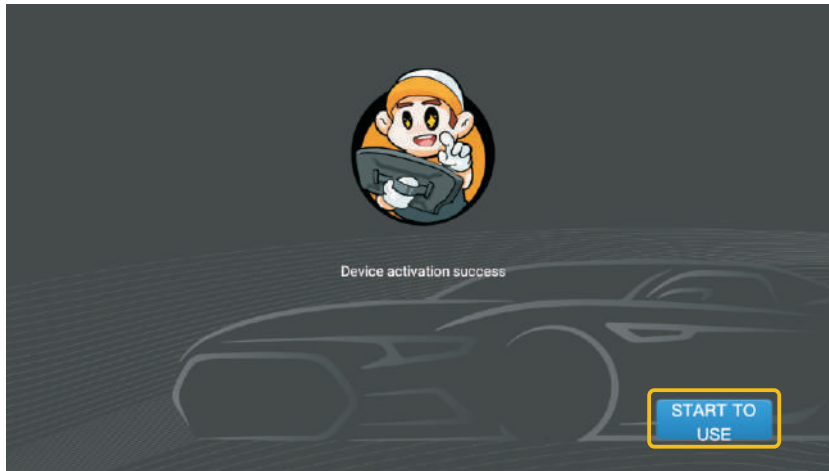

7) The device is successfully activated, click "START TO USE".

6.2 Online upgrad

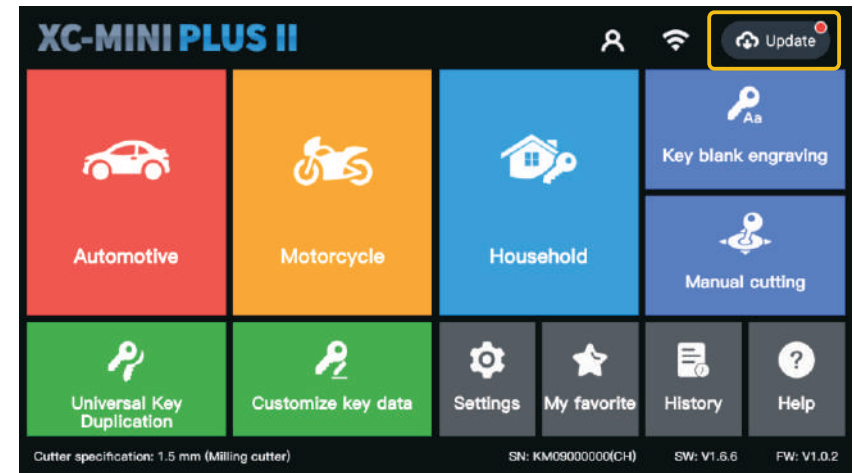

1) After the machine is connected to the Internet, click "Update" in the upper right corner of the main page.

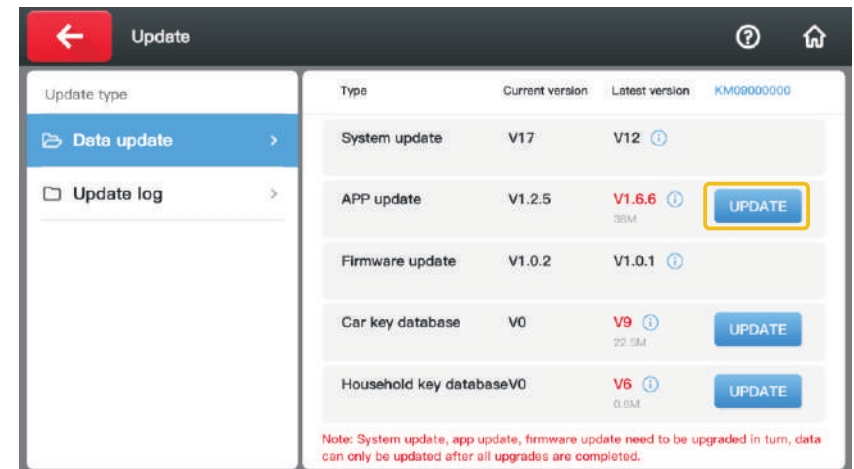

2) Click the "UPDATE" button on the right to upgrade.

6.3 Instructions for operation the machine

The machine adopts Android system, no need for “Height Calibration” and “Clamp Calibration”, just move the probe and cutter to the top.

6.3.1 Cutting calibration

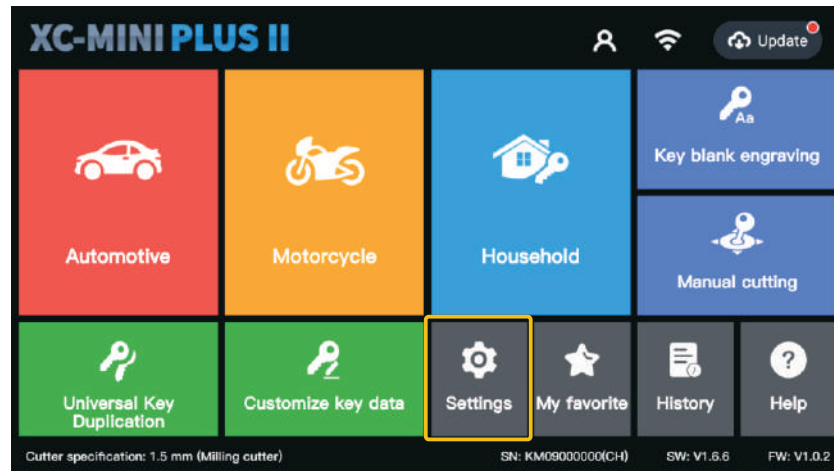

1) Enter the operation main interface and click on “Settings” .

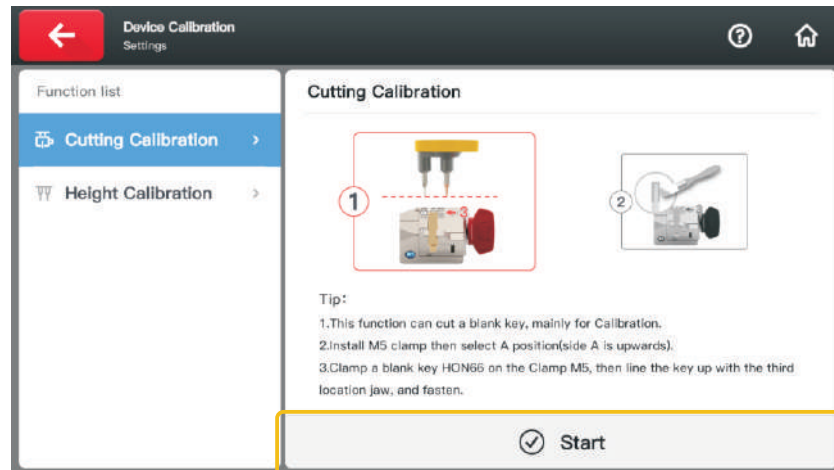

2) Click on “Cutting Calibration” .

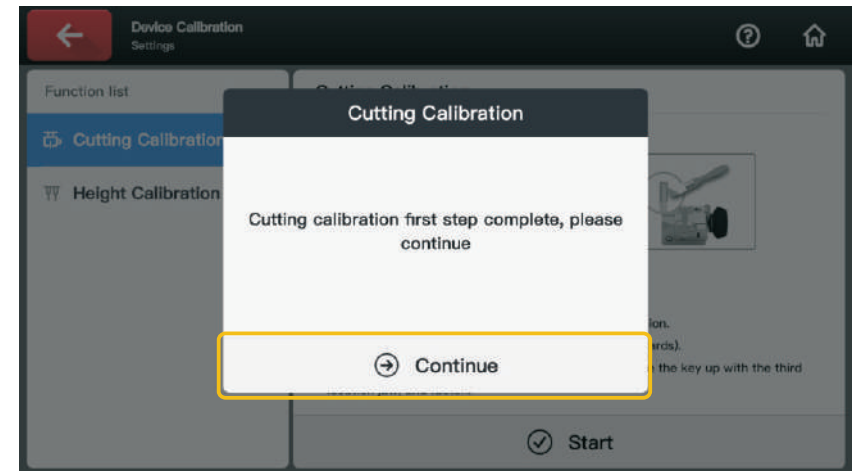

3) Operate by following the tips and click on “Continue”.

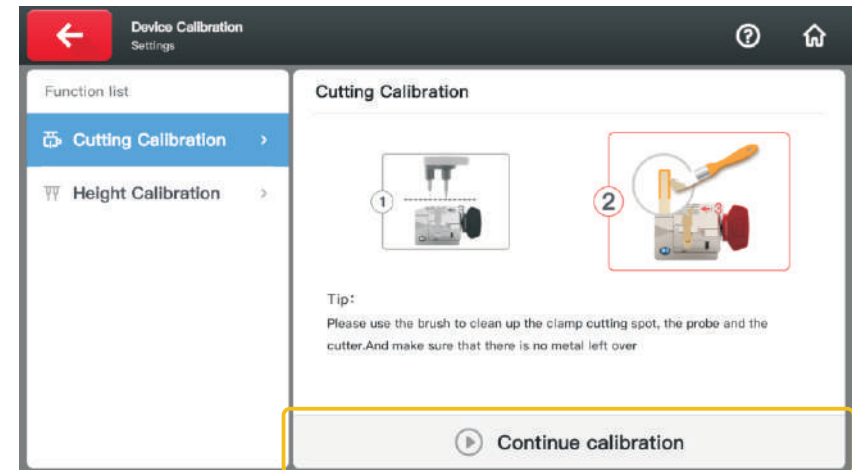

4) Clean the cutter and probe and working area with a brush. Click on “Continue calibration” and the now calibration has finished.

6.4 Automotice/Motorcycle Decode key

Method 1 (Brand/model)

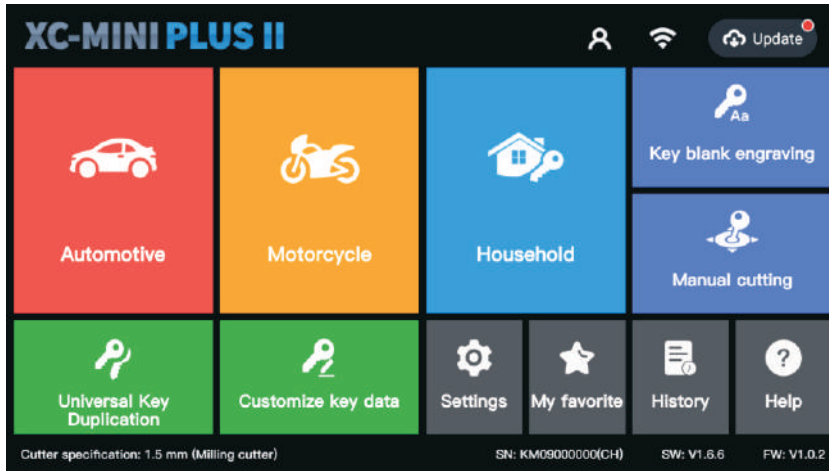

1) Enter the "Automotive/Motorcycle Key" interface.

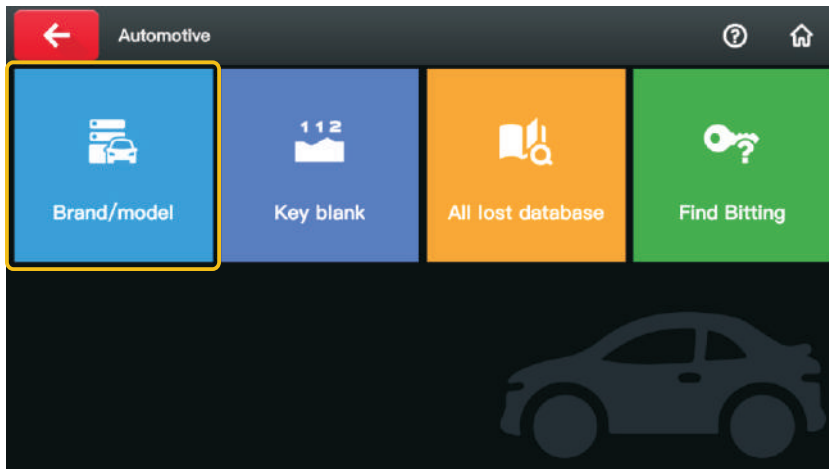

2) Click the "Brand/model" button.

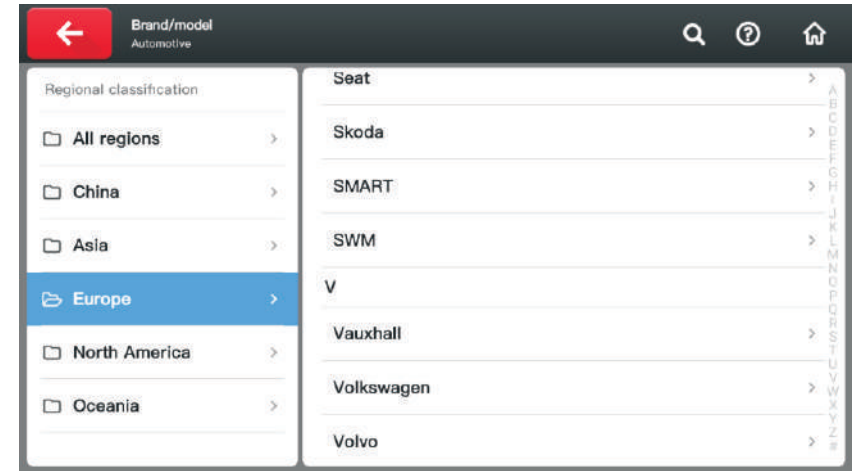

3) Select the manufacturer or click the "search button" to enter the brand or search by letter.

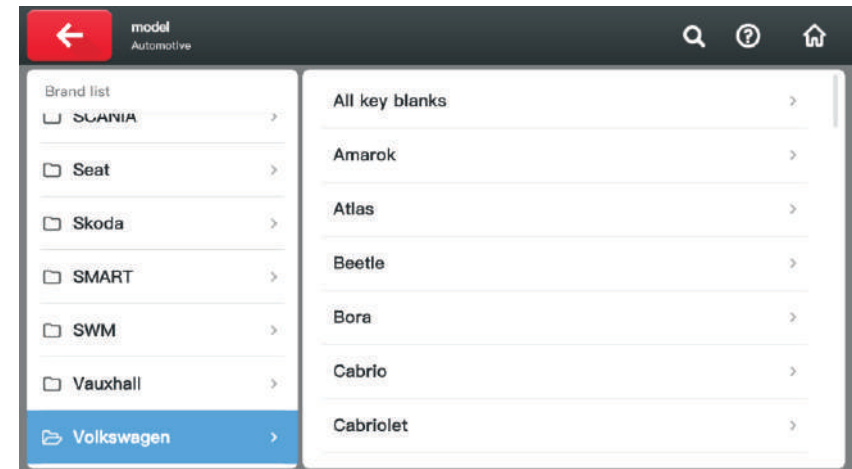

4) Select the model or click the "search button" to enter the model search.

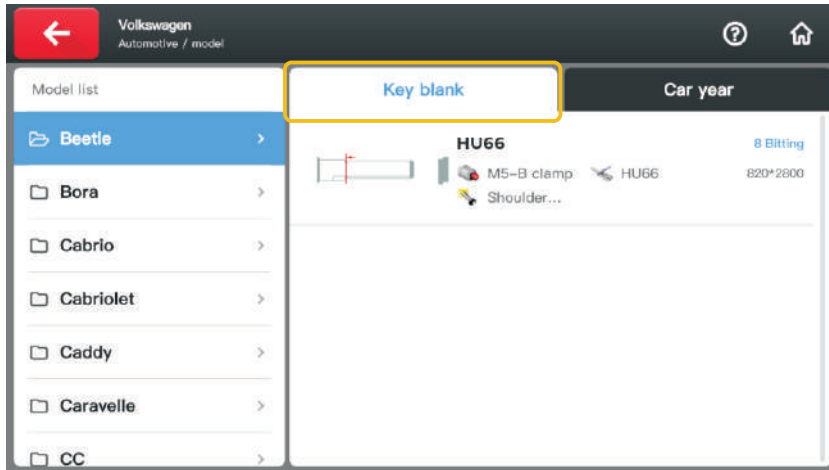

5) Select the key blank.

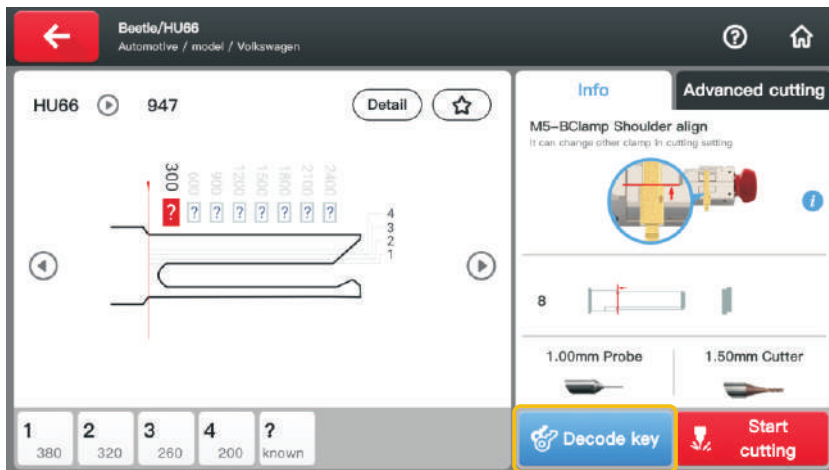

6) After setting the key blank according to the diagram on the right and click "Decode key".
(The clamp picture on the Info can be enlarged to see more clearly.)

Method 2 (Key blank)

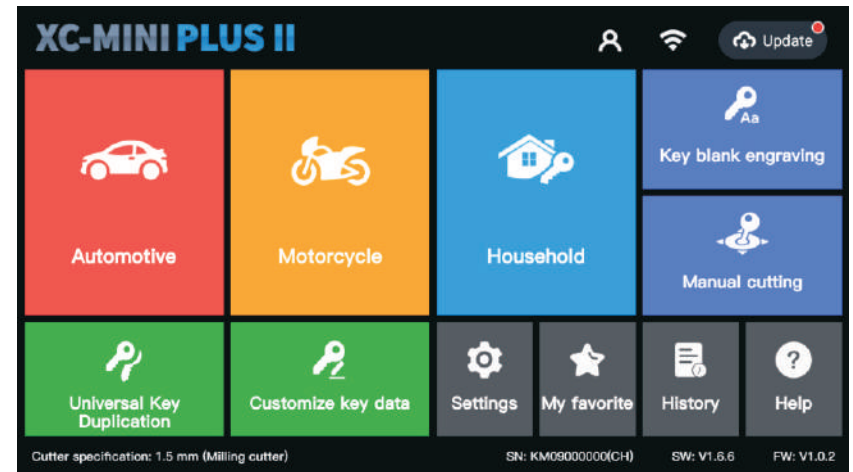

1) Enter the "Automotive/Motorcycle Key" interface.

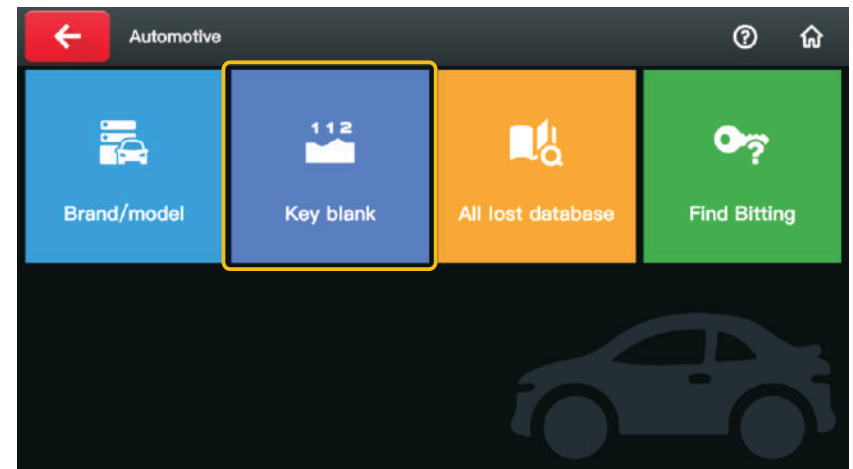

2) Click "Key blank" button.

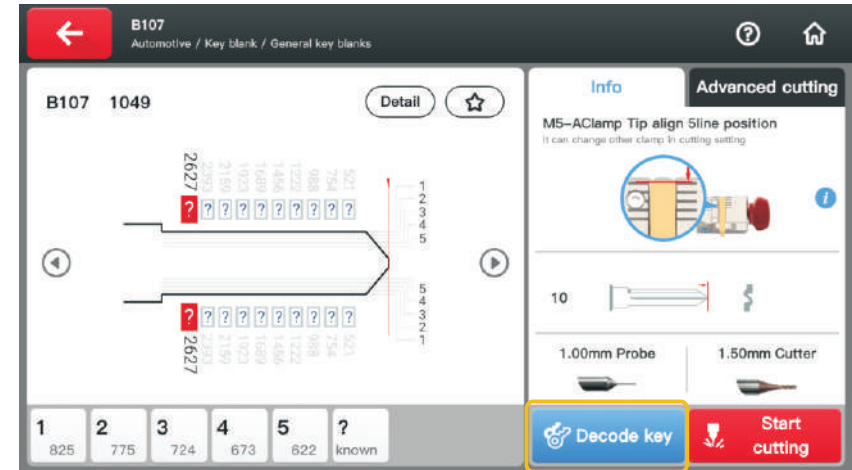
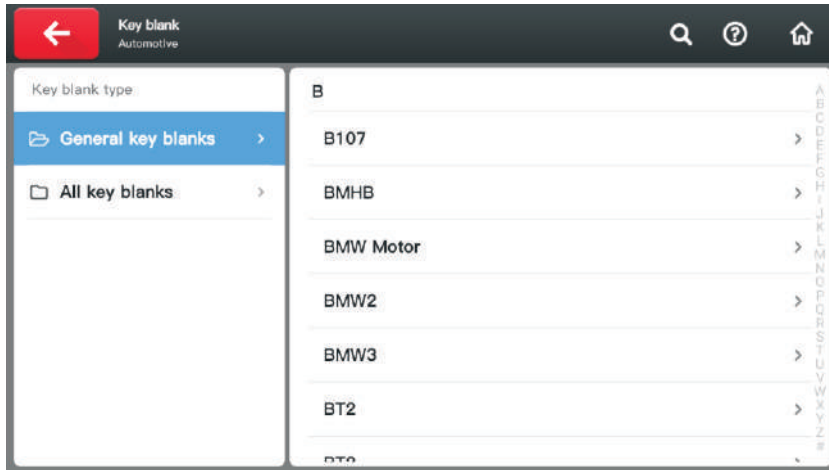

4) Install the key blank according to the diagram on the right and click "Decode key".

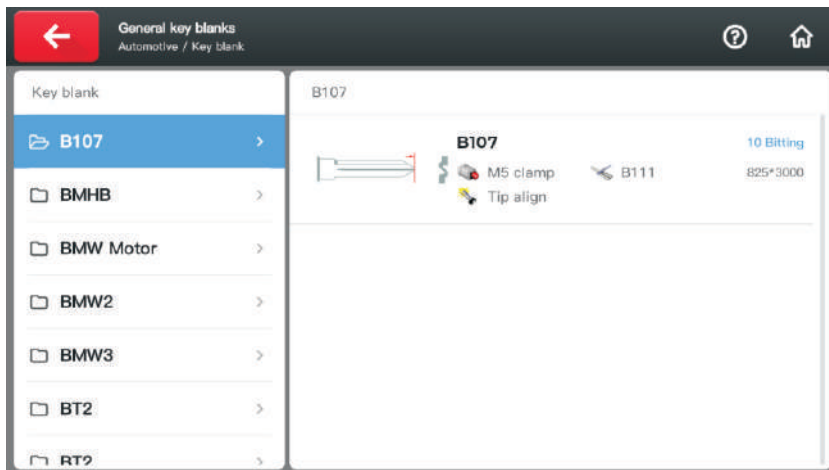

3) Select the key blank.

Method 3 (Universal Key Duplication)

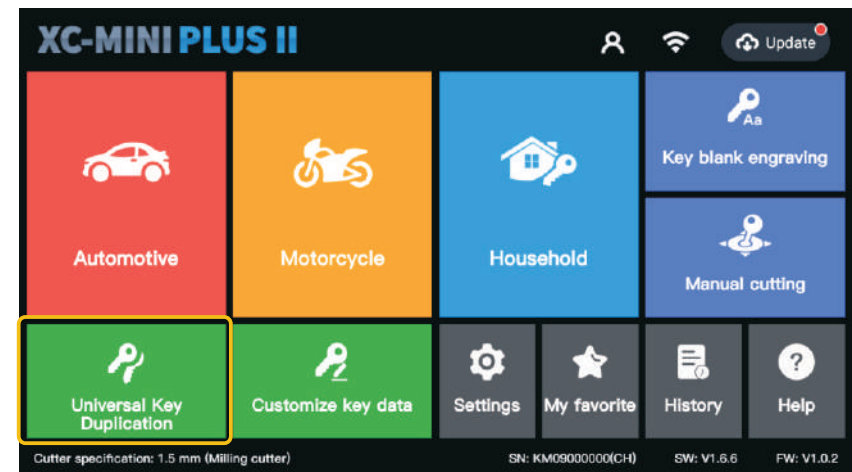

1) Click the "Universal Key Duplication" button. (On the main interface)

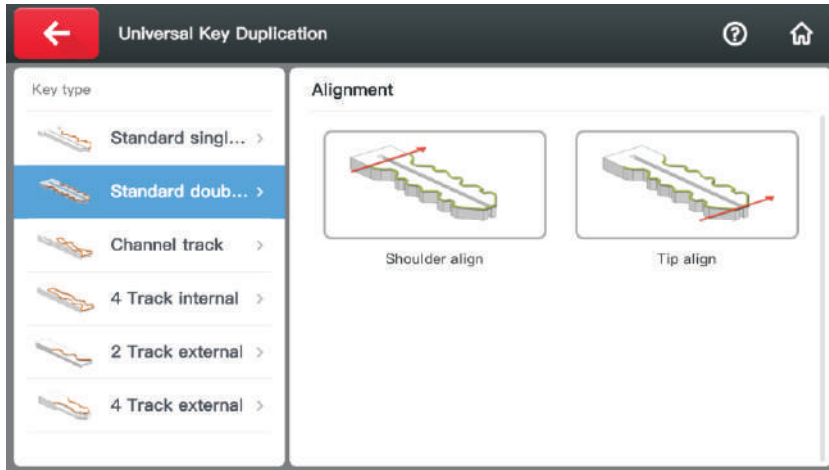

2) Choose the corresponding option according to the shape of the original car key.

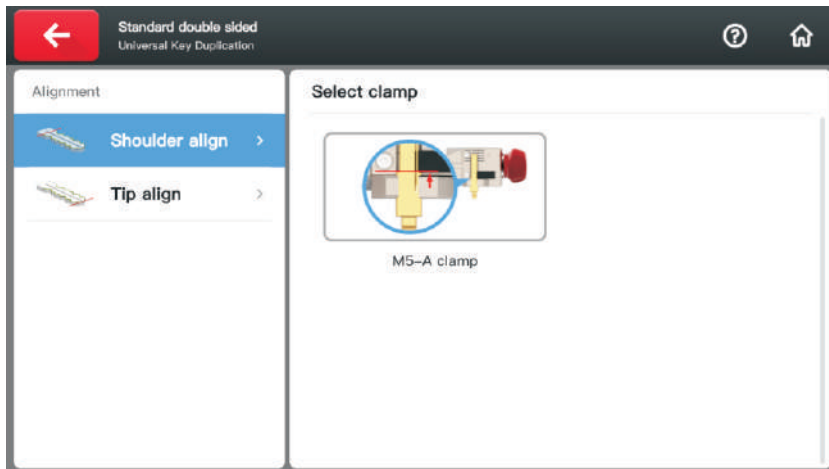

3) Choose the alignment and clamp.

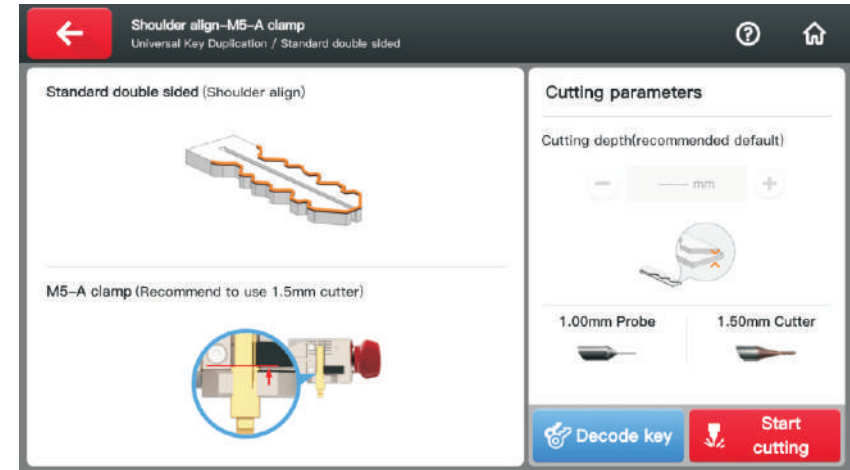

4) Install the original key according to the key alignment requirements prompted on the interface.

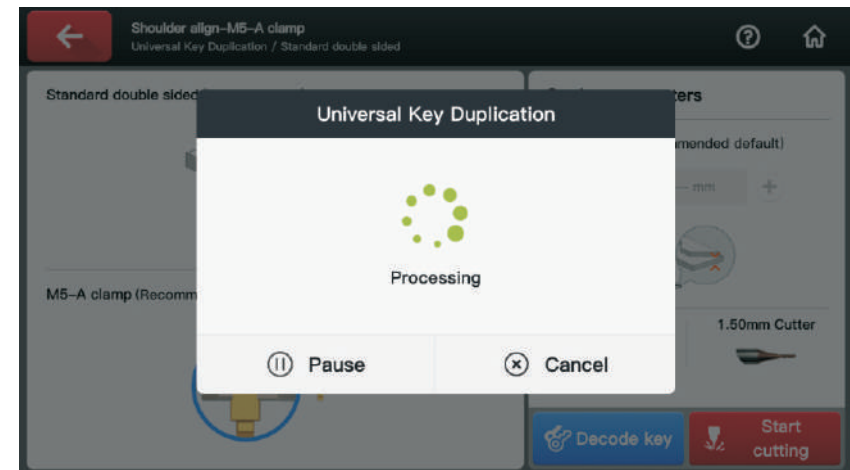

5) Click the "Decode key" button.

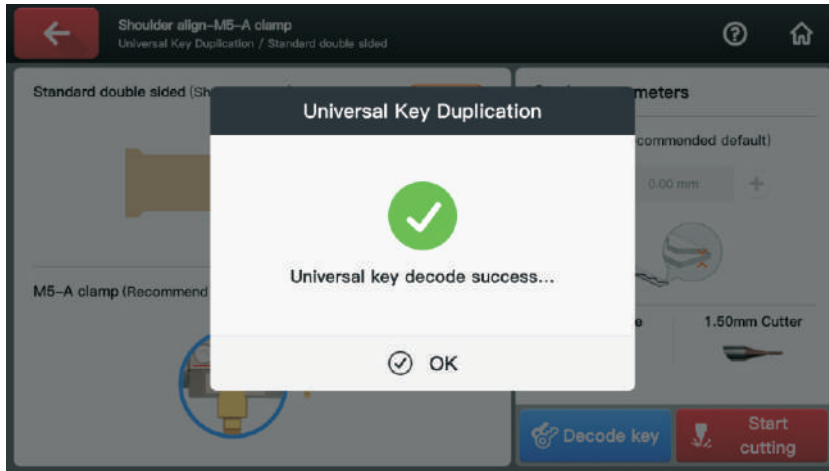

6) After the key decoding is completed, place the key blank as required and click to start cutting.

6.5 Automotive/Motorcycle key cutting

Method 1(Brand/model)

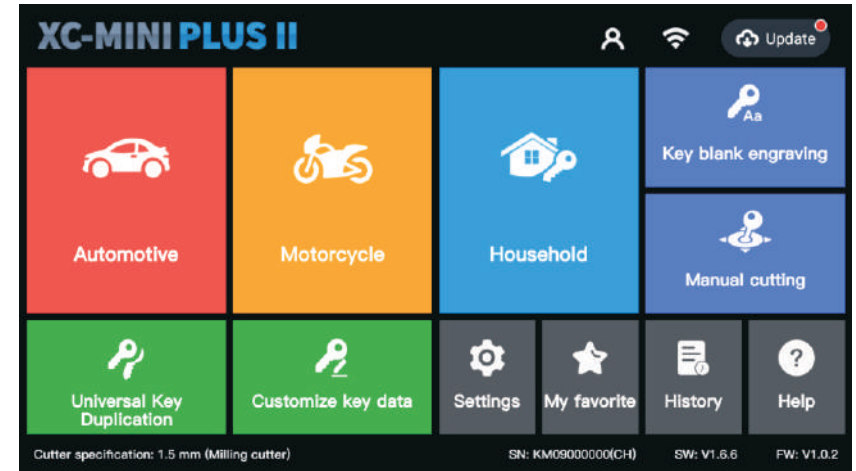

1) Enter the "Automotive/Motorcycle Key" interface.

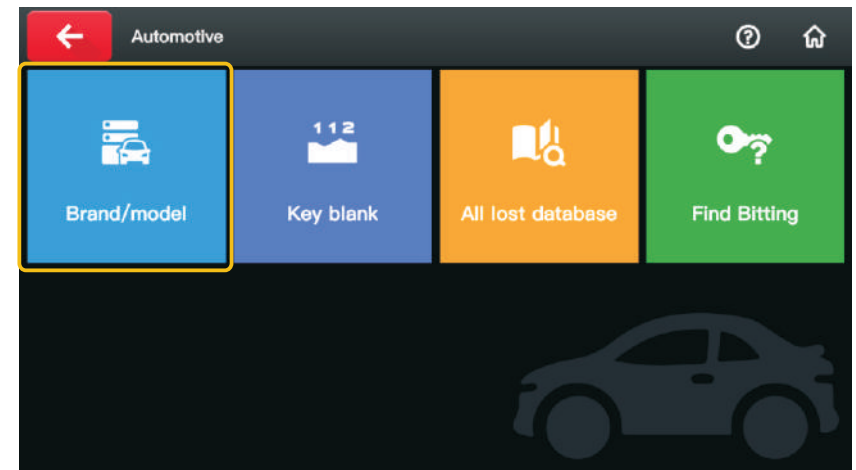

2) Click "Brand/model" button.

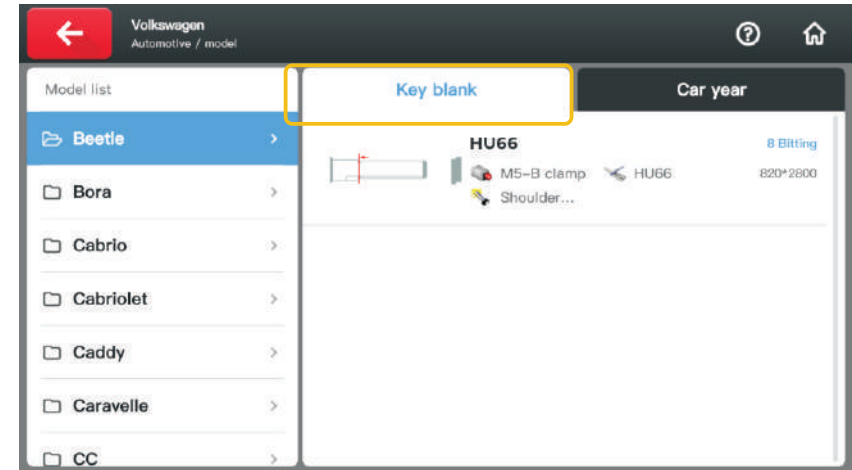
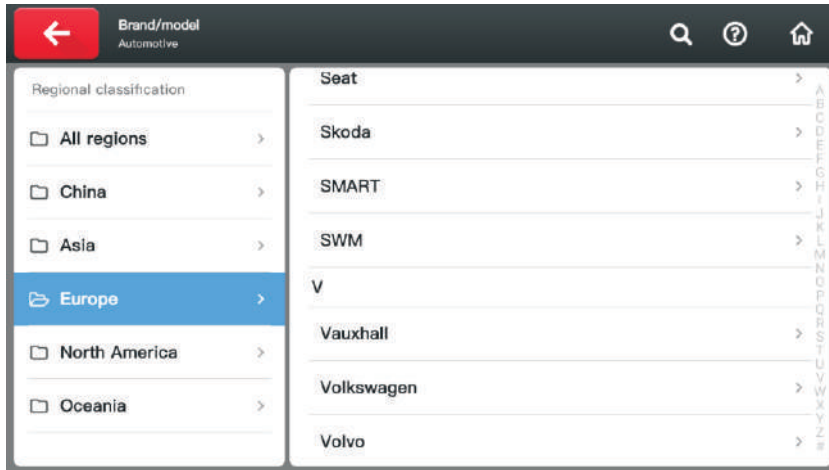

4) Select the key blank.

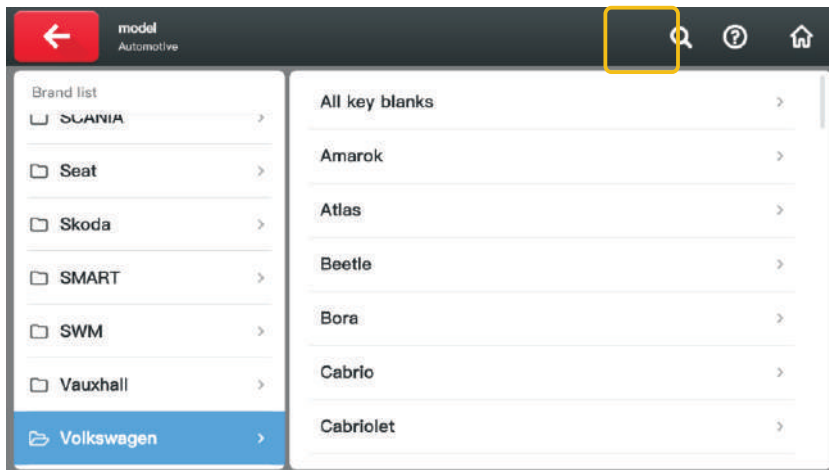

3) Select the manufacturer or click the "search button" to enter the brand or search by letter.

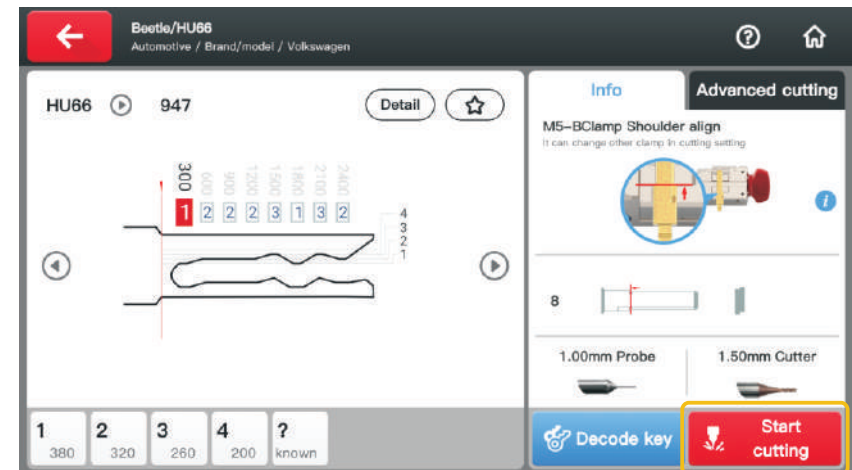

5) Install the key blank according to the diagram on the right, enter the key code and click the "Start cutting" button.

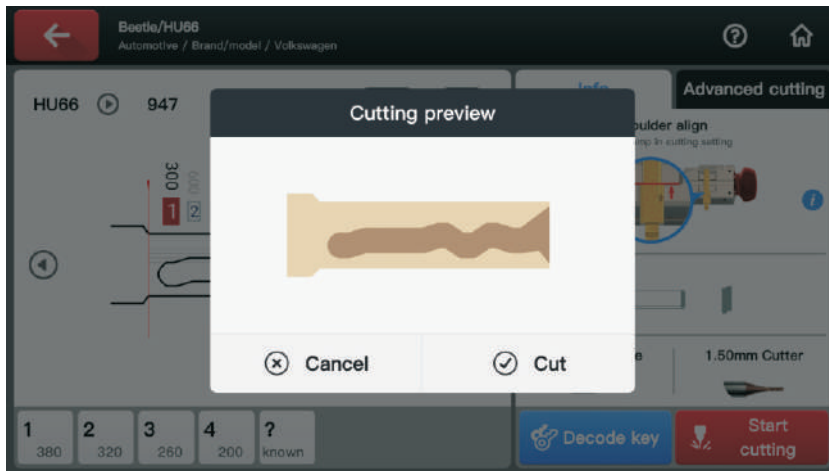
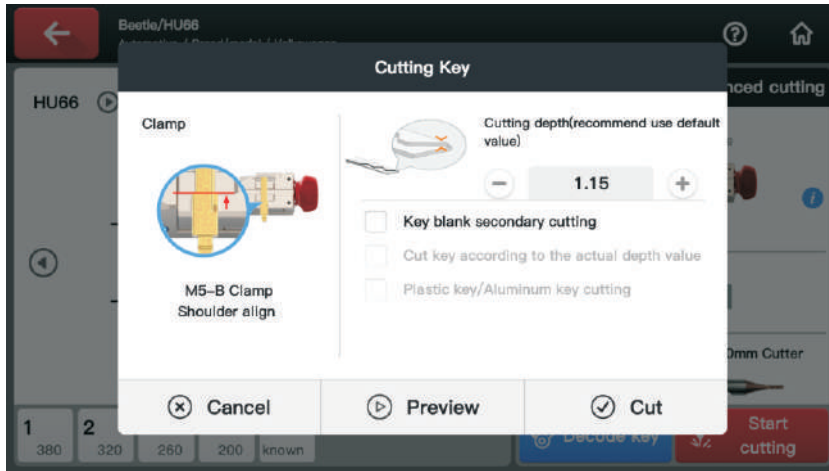

6) Click "Preview" to view the cutting effect (as shown in the figure above) or directly click "Cut" to process.

Method 2(Key blank)

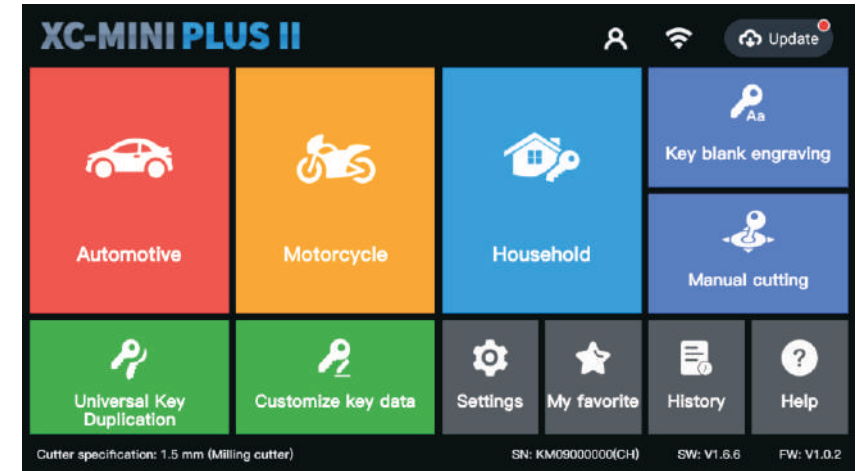

1) Enter the "Automotive/Motorcycle Key" interface.

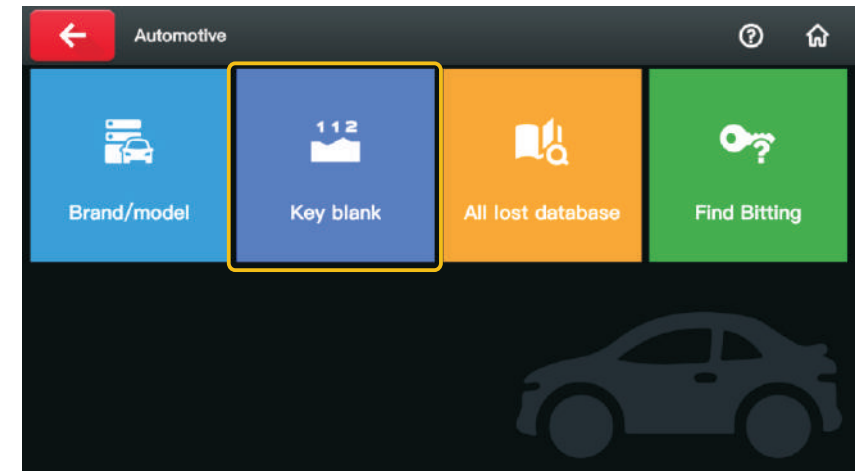

2) Click "Brand/model" button.

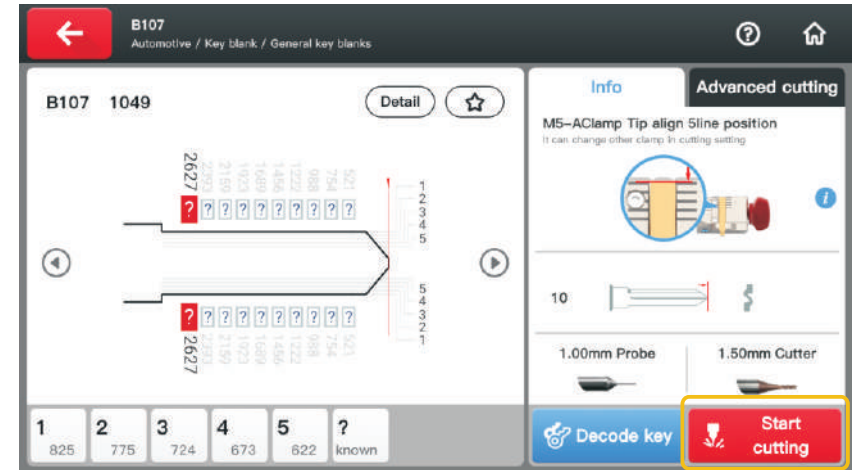
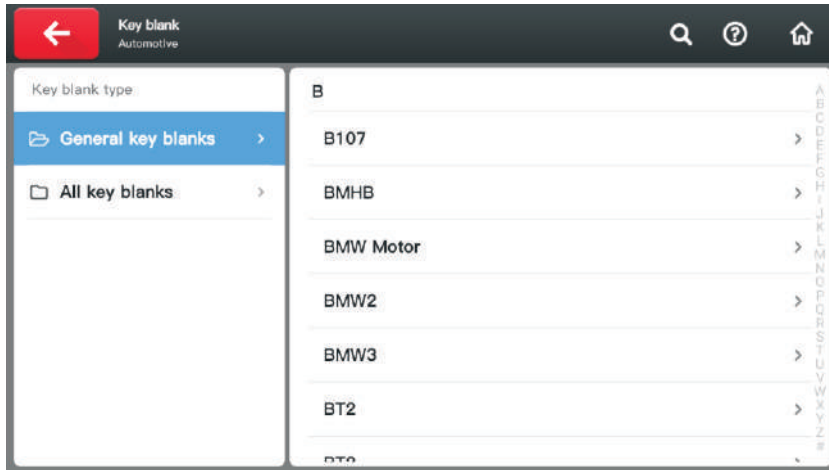

4) Install the key blank according to the diagram on the right, enter the key code and click "Start cutting".

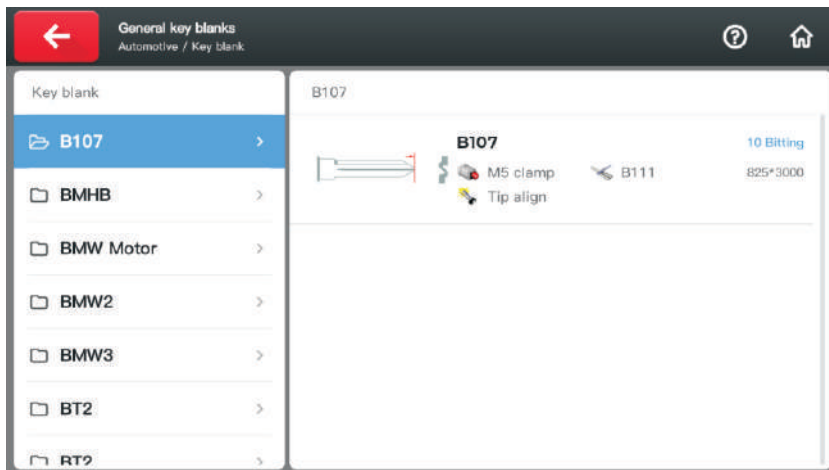

3) Select the key blank.

6.6 All key lost

This function supports query both online and offline.

There are three ways to obtain the key code for processing keys using the function of losing all keys :

- 1.The key plate provided by the car factory.
- 2.The key code is printed on the lock body of some models.
- 3.Other ways to get the key code.

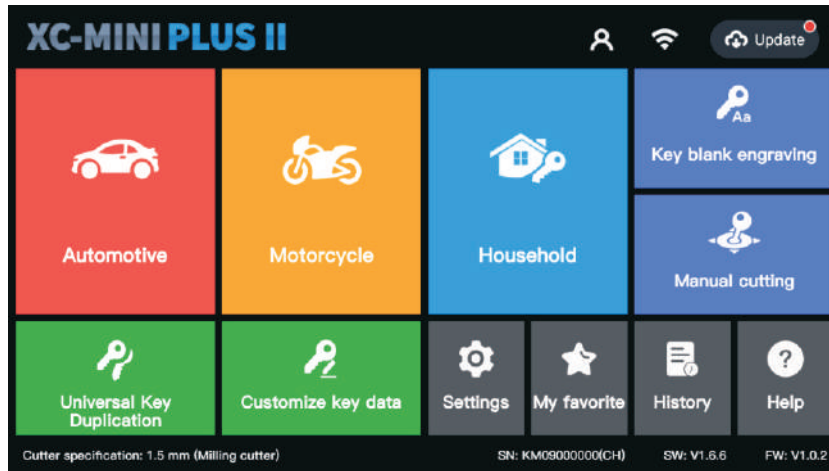

- 1) Enter the "Automotive/Motorcycle Key" interface.

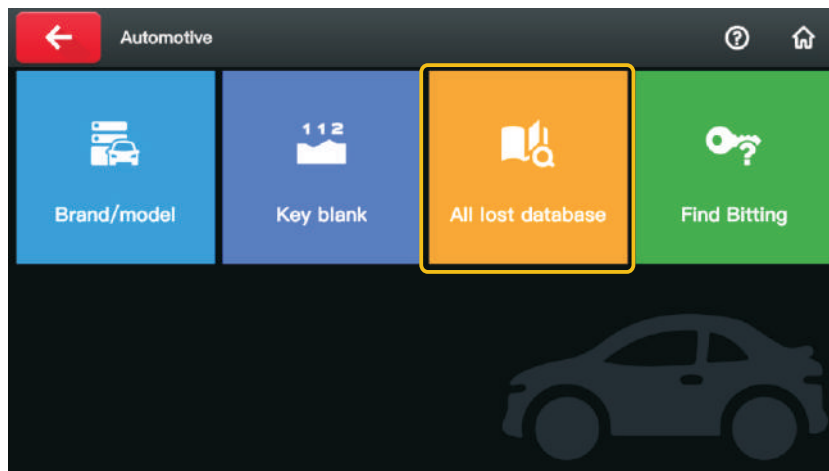

- 2) Click the "All key lost".

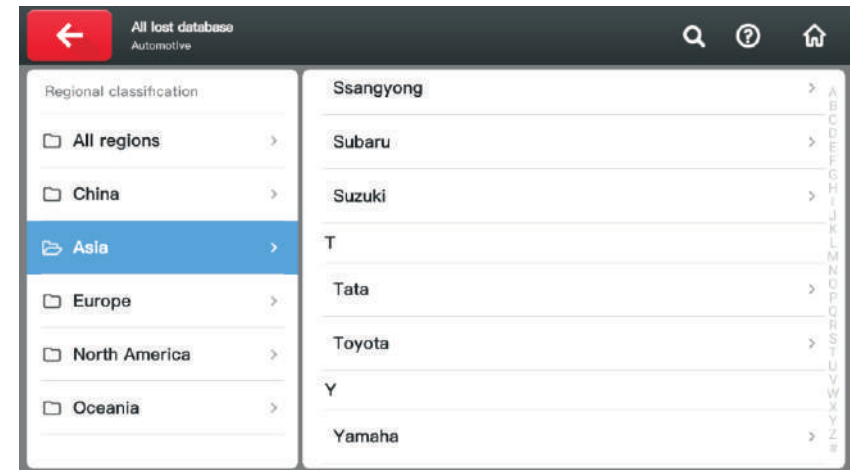

- 3) Select the manufacturer or click the "search button" to enter the brand or search by letter.



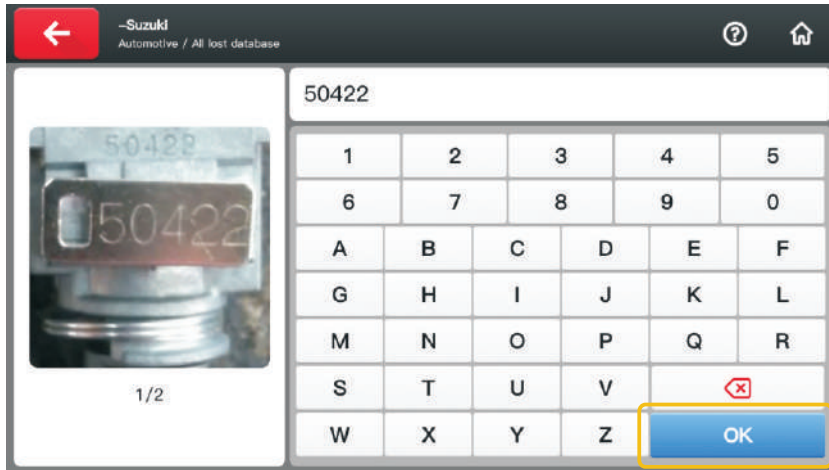

- 4) Enter the key code according to the icon on the left and click "OK" to query.
(The legend on the left is for reference only, and does not include all key code types)

6.7 Find Bitting

Compared with the ignition lock, the door locks and tail box locks of some models are missing lock plate pieces. You can disassemble the car lock to find the key bit missing piece position, replace it with "?", and enter it into the Find Bitting.

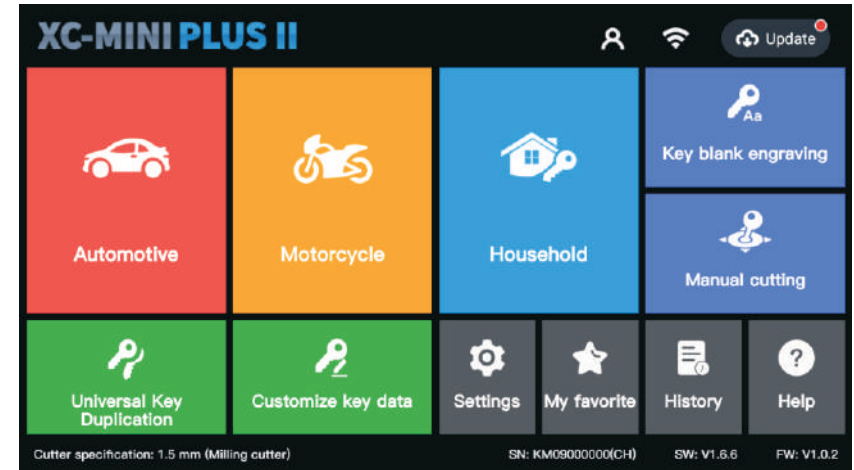

- 1) Enter the "Automotive/Motorcycle Key" interface.

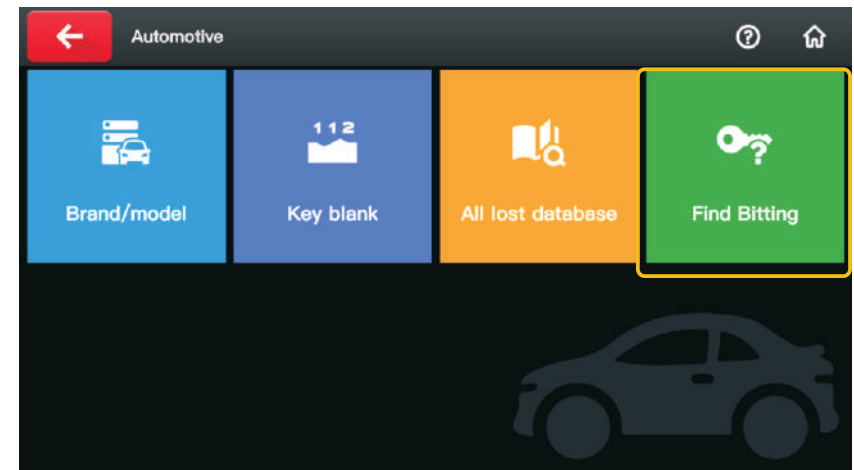

- 2) Click the "Find Bitting".

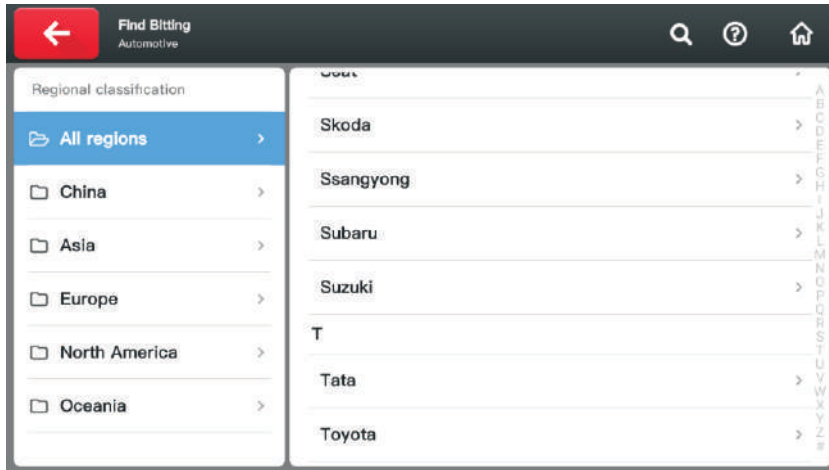

3) Select the manufacturer or click the “search button” to enter the brand or search by letter.

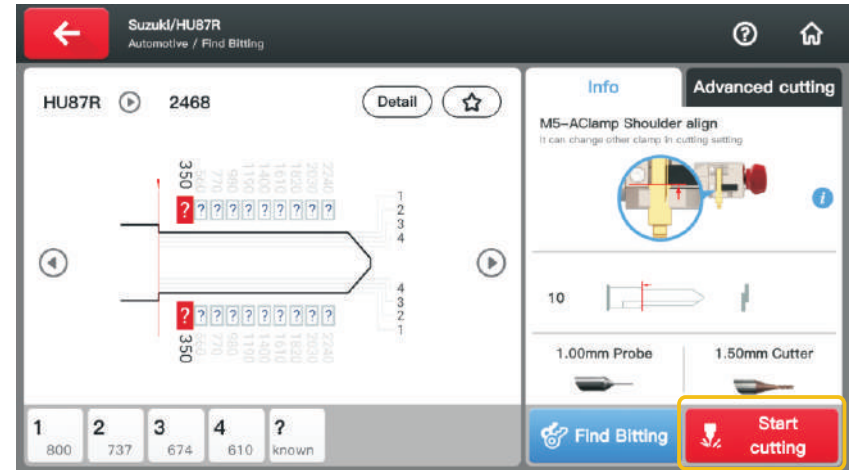

5) Enter the known key bit, if the key bit is not clear, directly enter “?” and click “Find Bitting” after input. It can processed according to the key bit which calculated by the system.

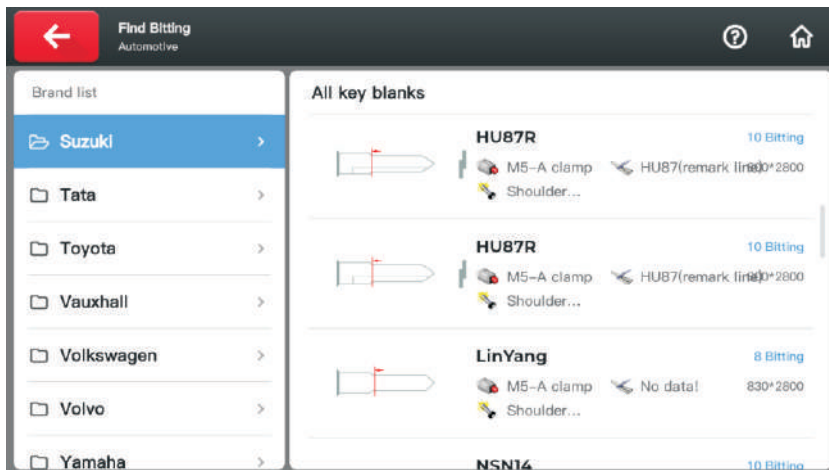

4) Select the key blank.

6.8 Household

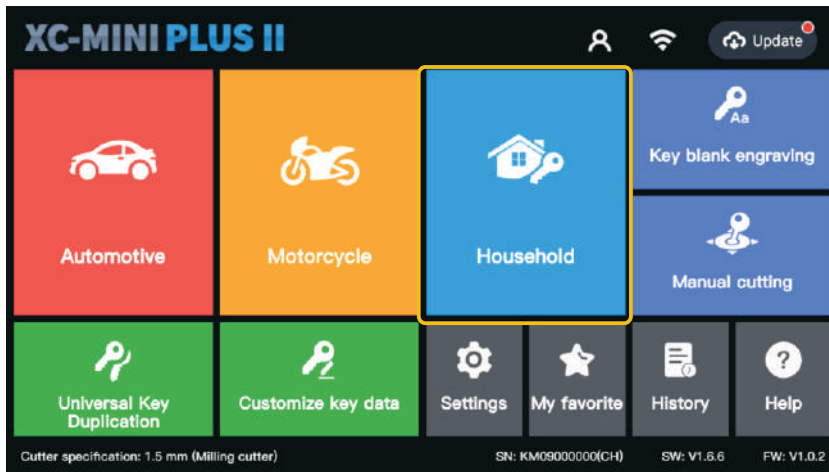

1) Enter the "Household" interface.

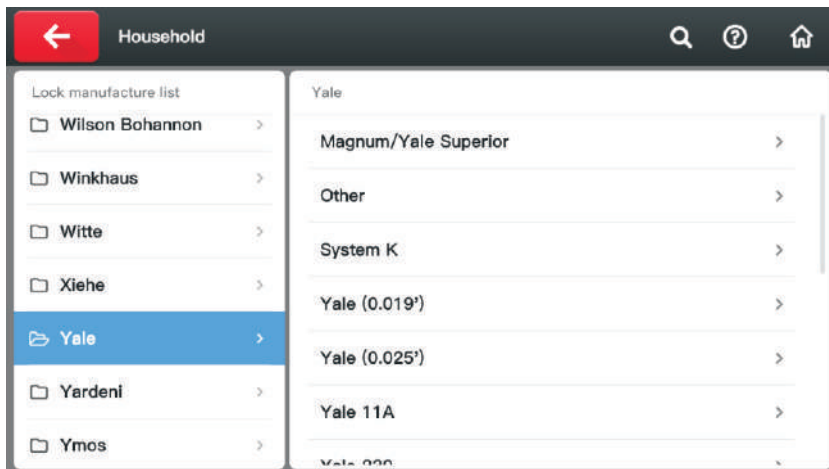

2) Choose lock factory brand and key options.

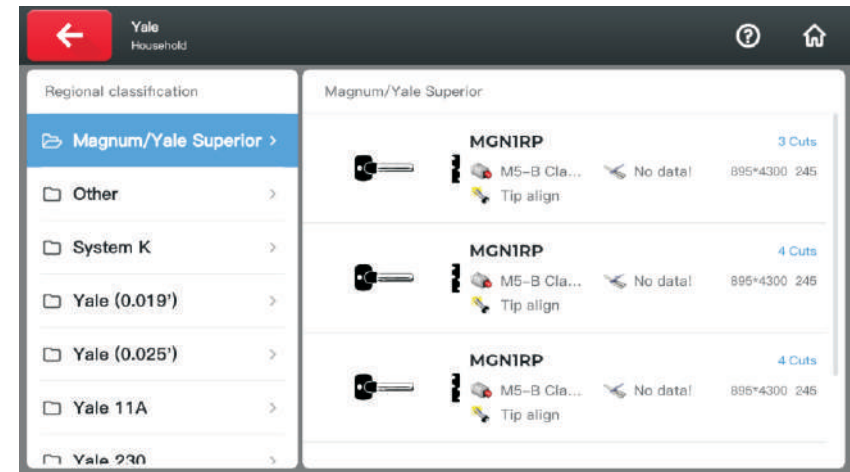

3) Select the type of key blank.

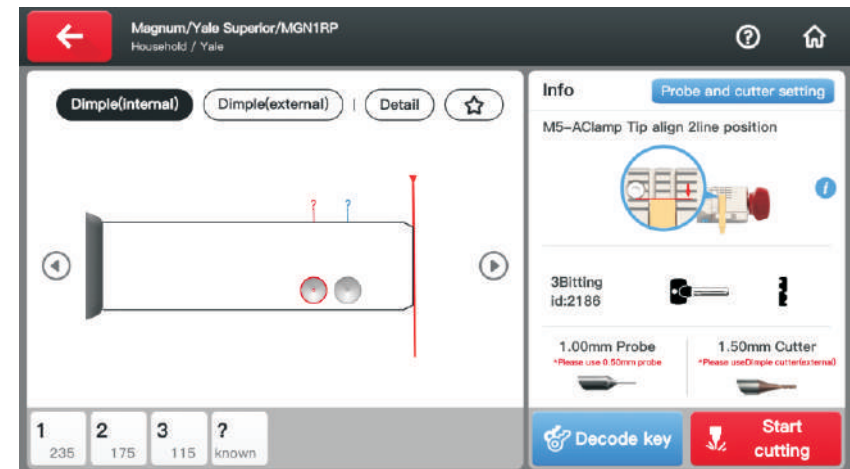

4) Select the cutting method of the key.

6.9 Key blank engraving

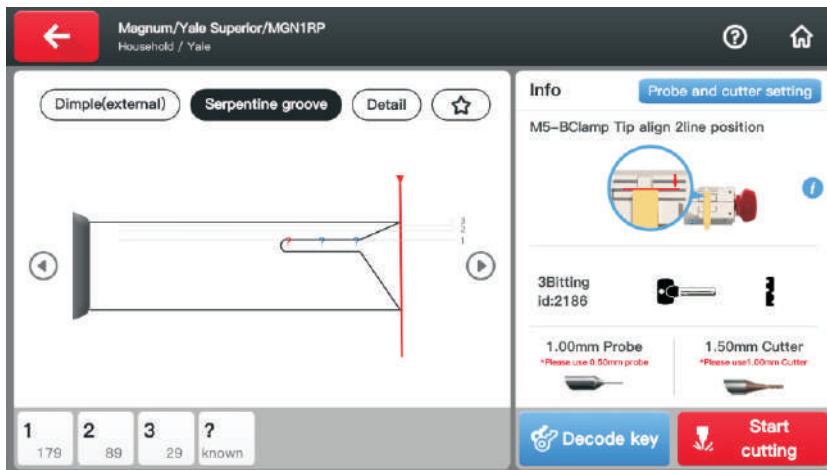
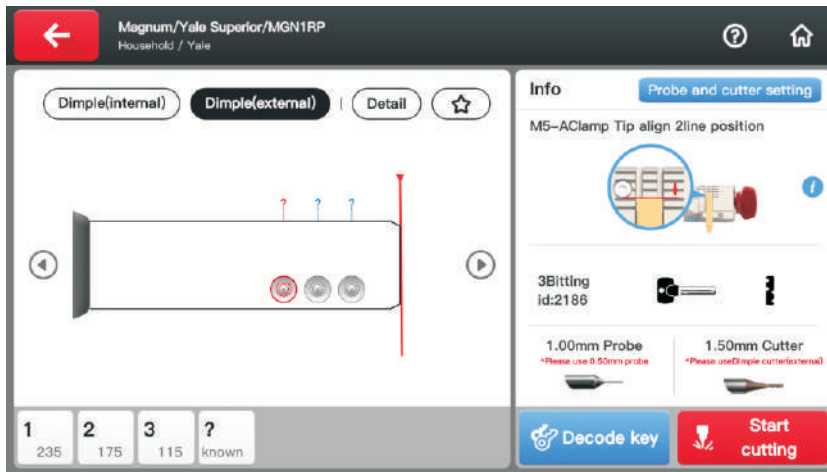

5) Install the key blank according to the diagram on the right, enter the key code and click "Start cutting".

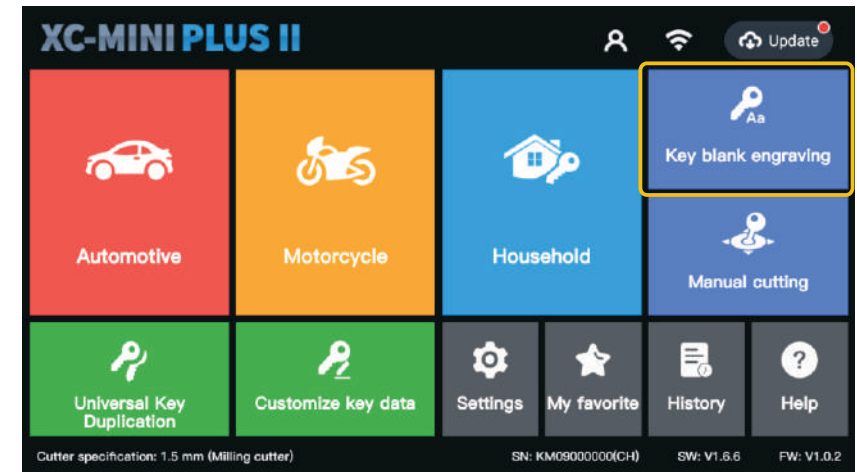

1) Click the "Key blank engraving" option.

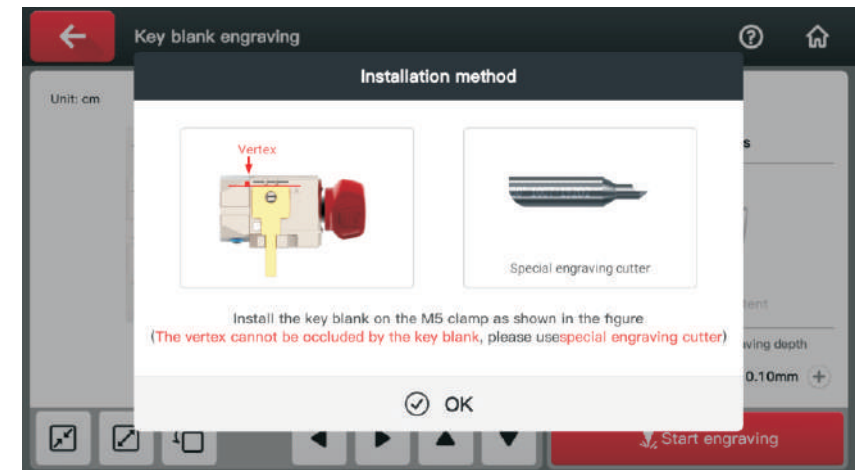

2) Install the key blank and engraving cutter as shown in the figure.

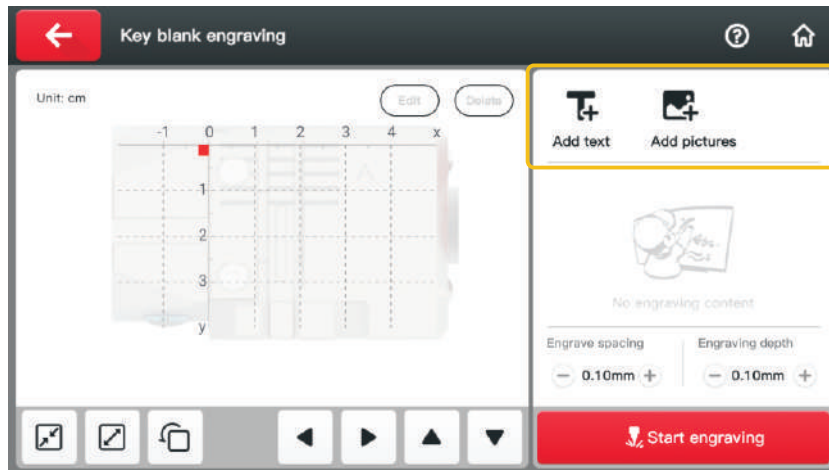

3) Click "Add text" or "Add pictures" button.

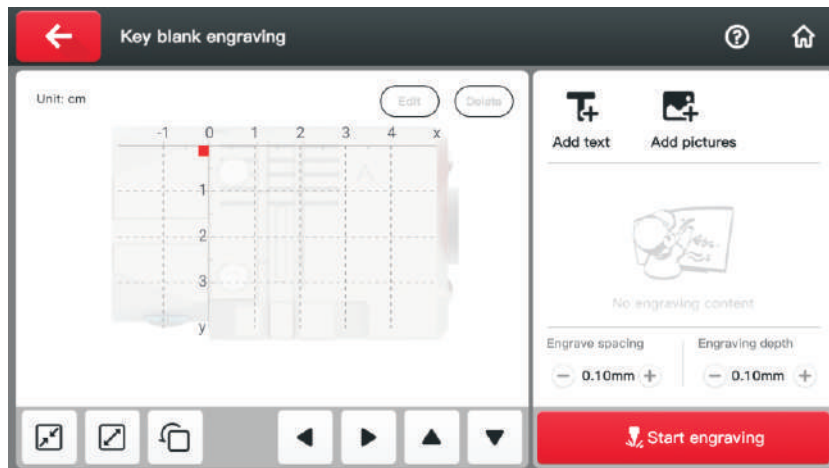

- 4) ① Edit and delete the added text
 ② Enlarge and reduce the added text
 ③ Rotate the added text
 ④ Move the added text to confirm that the text is correct, click to start engraving
 (Notes: Engraving time depends on how much engraving content)

6.10 Manual cutting

This function can be used to modify the key blank such as thinning and widening the key.

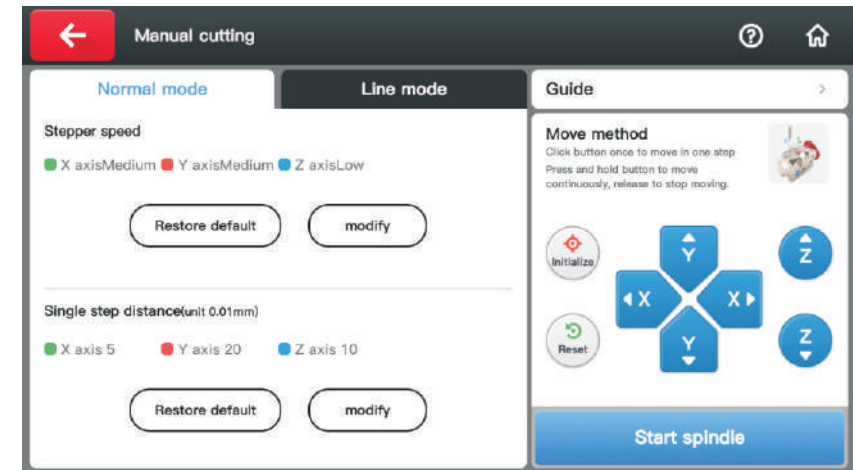

Note: You must click the "Reset default" button before using this function, and click "modify" after the operation is completed. The protective cover must be covered when the machine is cutting. The user can adjust the parameter settings on the right to adjust the working speed of the machine.

Move method:

1. Click button once to move in one step;
2. Press and hold button to move continuously, release to stop moving.

6.11 Customize key data

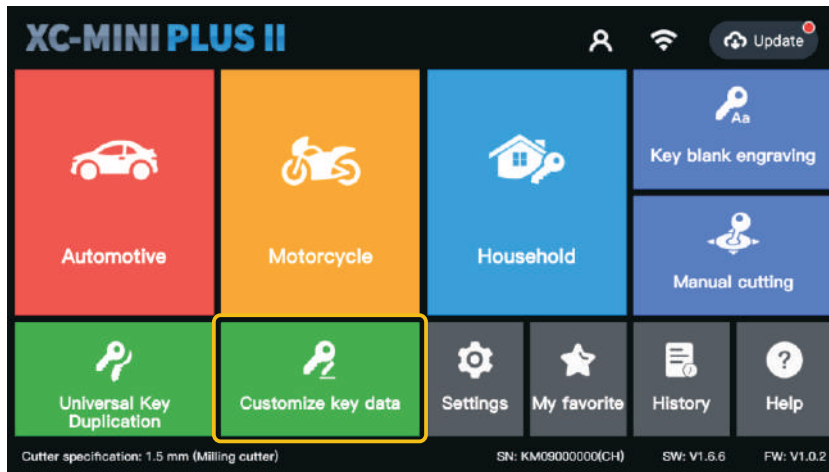

1) Click the “Customize key data” option.

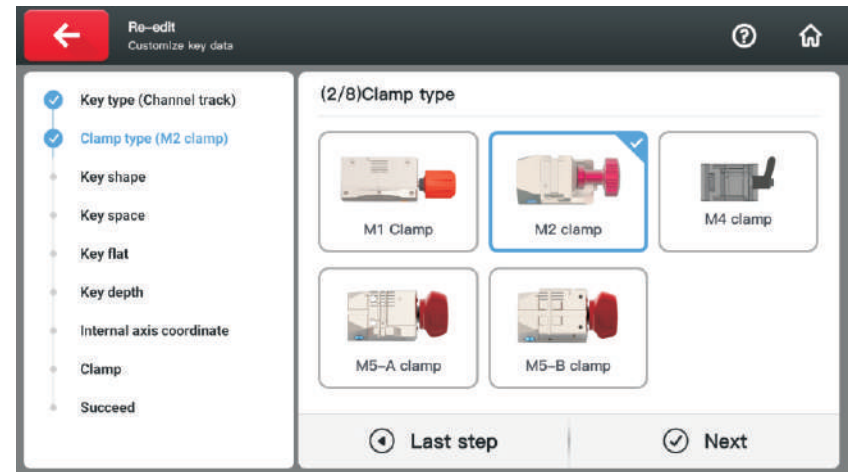

3) Select the type of clamp.

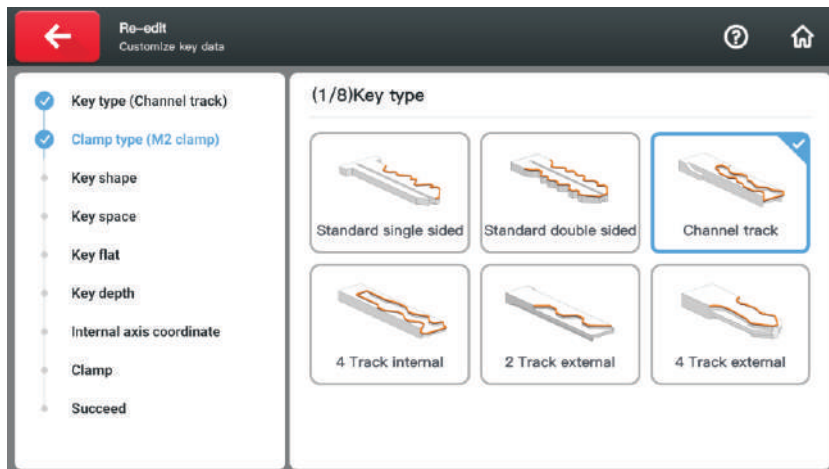

2) Select the type of key blank.

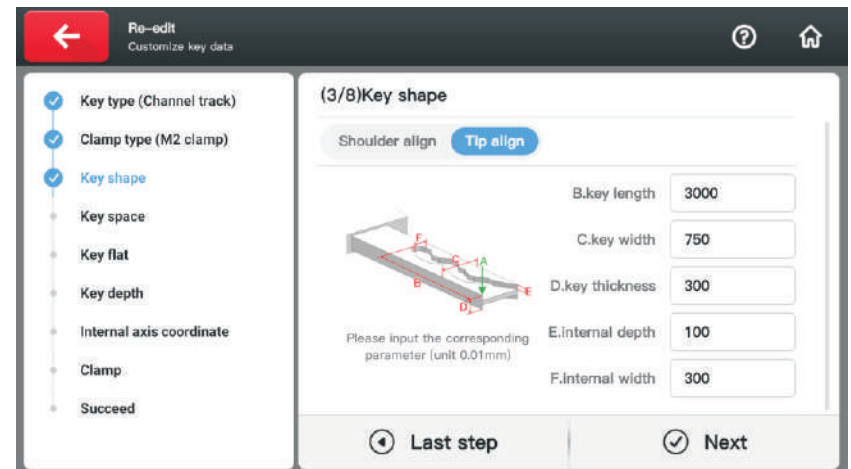

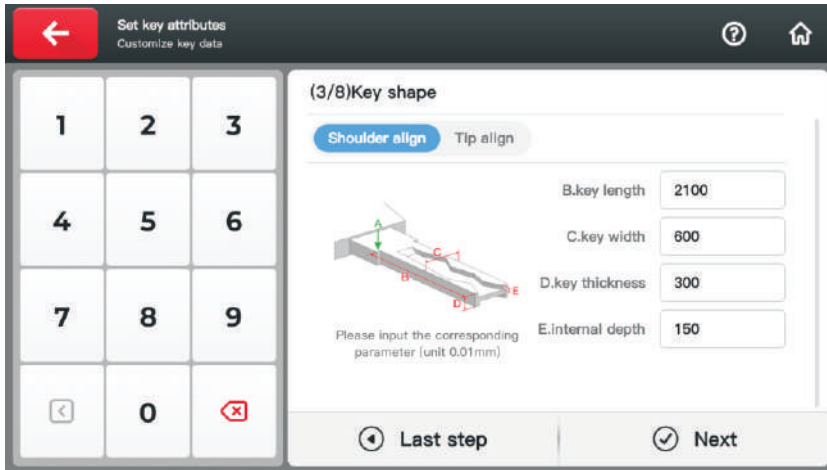

4) Select shoulder align or tip align and enter the corresponding parameters of the key.

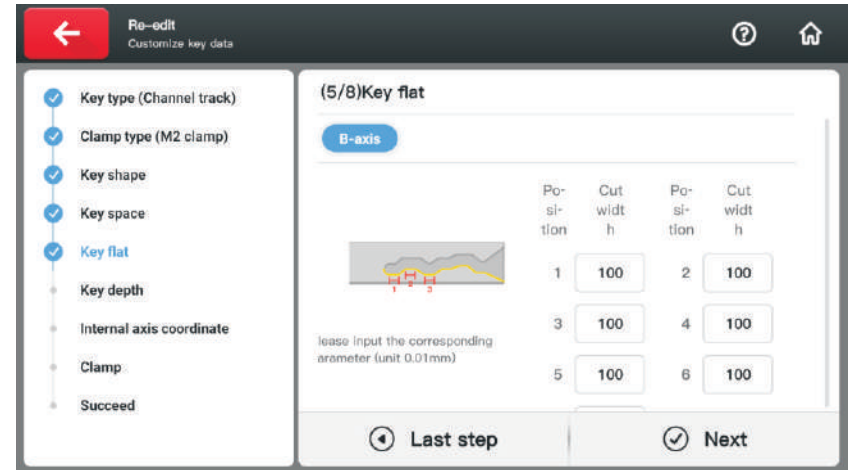

6) Enter the A-axis and B-axis tooth width parameters.

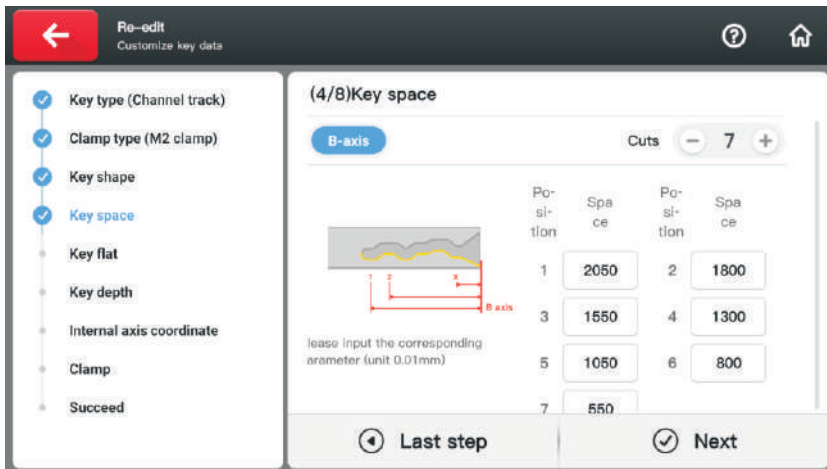

5) Enter the A-axis and B-axis tooth width parameters.

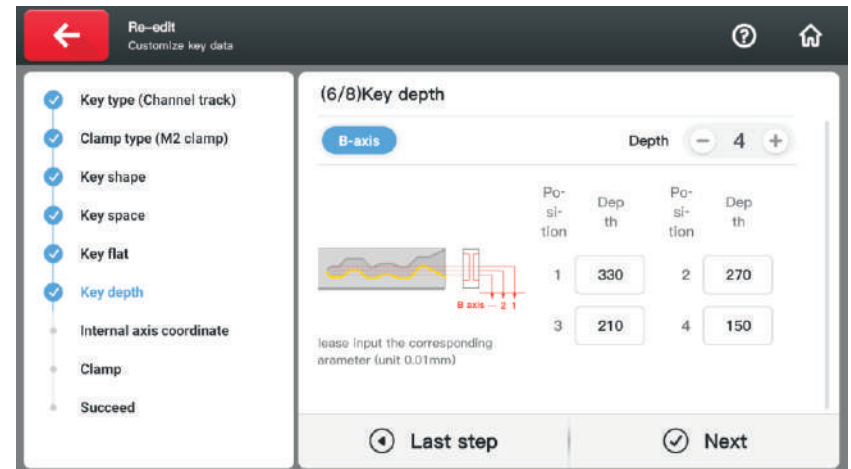

7) Enter the key bit depth parameter.

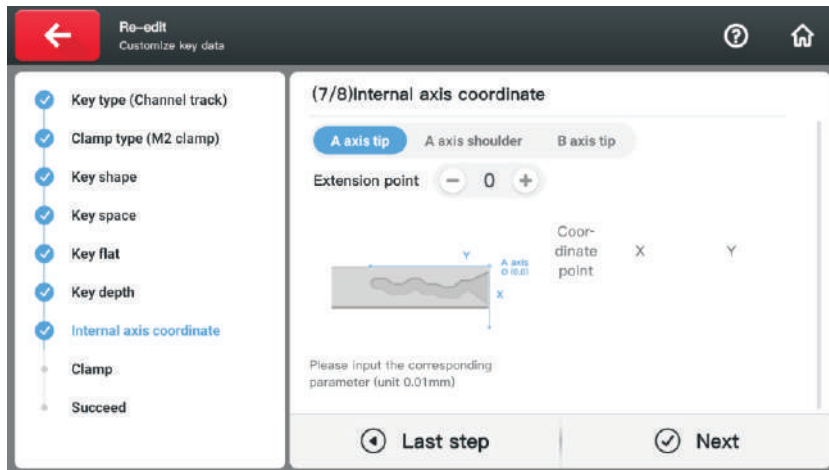

8) Enter the coordinates of the A-axis head and A-axis tail groove edge distance.

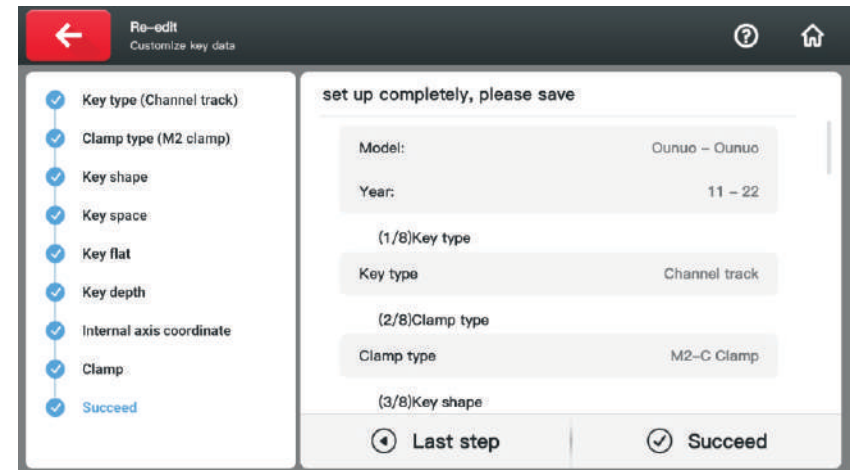

10) After verifying the parameters, click "Succeed".

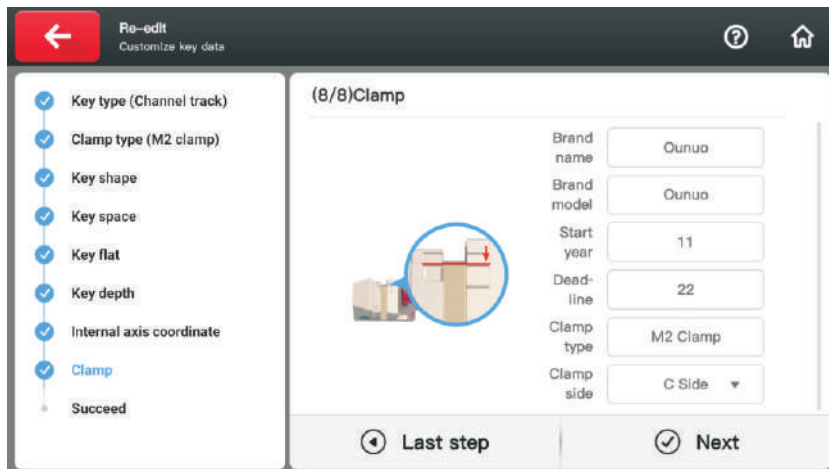

9) Choose the type of the clamp.

7. Maintenance

- Please clean the area around clamps with a brush before the machine starts to work. This is to assure cutting precision and avoid components damage by metal particles.
- To avoid damage or corrosion to the machine, please do not use detergent or other cleaning products to clean the machine.
- Please do not flush or wet the machine with water, in case rust and electrical current leakage.
- Under any circumstance, please do not try to clean the working area with air guns and drying machines, in case any metal carvings getting inside the machine.

8. After-sale description

Regarding to customer service and technical support, please contact distributors or Xhorse online customer service team by scanning the QR code below and downloading Xhorse official App.



Scan QR Code to download Xhorse APP

All the information and illustrations in this document are for guidance only. Xhorse reserves the right to alter products designs, dimensions or info to improve the products quality. The contents of this document are fully protected by Copyright and may not be copied or reproduced in any form (e.g. mechanical, electronic, printing or video recording), without permission from Xhorse.



